



**Maharshi Dayanand University, Rohtak**

# Annual Programme

2011-2012



**Maharshi Dayanand University  
Sports Council**

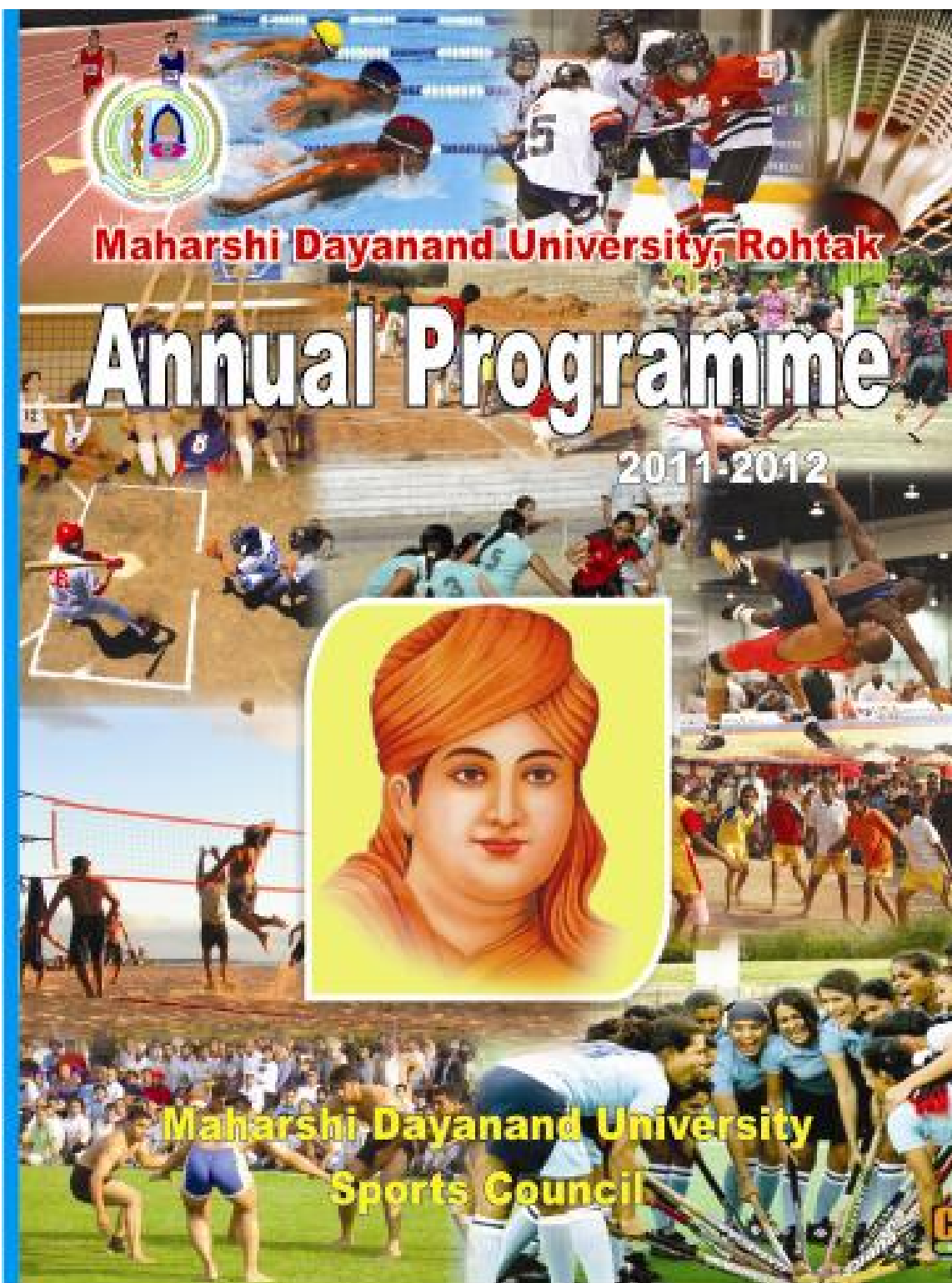



**Prof. R.P. Hooda**  
VICE-CHANCELLOR



**Prof. S.P. Vats**  
REGISTRAR



**Prof. Rajbir Singh**  
DEAN STUDENTS' WELFARE  
&  
PRESIDENT MDUSC



**Dr. Davinder Singh Dhull**  
DIRECTOR SPORTS  
&  
SECRETARY MDUSC



## आभारोक्ति

महर्षि दयानन्द विश्वविद्यालय खेल परिषद् के लिए यह शुभ अवसर है जहाँ विश्वविद्यालय से सम्बन्धित सभी महाविद्यालयों के प्रधानाचार्यों, शारीरिक शिक्षा के प्रवक्ताओं, खेल प्रशिक्षकों का स्नेह एवम् सहयोग हमेशा मिलता रहा है। जिसका परिणाम साक्षात् रूप में आपके सामने है। गत वर्ष आप सभी के सहयोग से महर्षि दयानन्द विश्वविद्यालय रोहतक ने खेलों में नए आयाम स्थापित किए हैं व भारत के खेल मानचित्र पर सभी विश्वविद्यालयों में प्रथम विश्वविद्यालयों में शामिल हुआ। खेल कैलेंडर (कार्यक्रम) के माध्यम से आपको पूरे वर्ष की खेल जानकारी उपलब्ध करवाई गई है। इस प्रयास में अगर कोई त्रुटि रह गई हो तो आपके सुझाव स्वागत के साथ भविष्य में शामिल किए जायेंगे। विश्वविद्यालय के उच्चाधिकारीगण, प्रशासन, अपने सभी सहयोगी कर्मचारियों एवम् सभी महाविद्यालयों का वर्ष 2010-2011 के सफल आयोजन के लिए मैं खेल परिषद् की तरफ से आपका हार्दिक आभार प्रकट करता हूँ एवम् आपके सहयोग के लिए हमेशा ऋणी रहूँगा। मुझे पूर्ण विश्वास है कि आप खेलों के विकास की इस डगर में गत वर्ष की तरह अपना पूर्ण सहयोग देंगे।

उज्ज्वल भविष्य की शुभकामनाओं के साथ,

**डा० देवेन्द्र सिंह दुल**  
खेल निदेशक,  
महर्षि दयानन्द विश्वविद्यालय,  
रोहतक





# MAHARSHI DAYANAND UNIVERSITY, ROHTAK

## CALENDAR OF SPORTS COUNCIL 2011-12

Sr. No.	Name of the Game	Date of Inter-College Tournament	Venue of Tournament.	Date of Selection Trials	Date of NZ/AIUU Tournament	Venue of AIIU Tournament
1	Cross Country (M & W)	28.8.11	MDU Rohtak	28.8.11	3.10.11	MDU
2	Kho Kho (W)	2 to 5.9.11	VMM Rohtak	5.9.11/11 am	15.10.11	Mumbai
3	Kabbadi (W)	5 to 8.9.11	JVMGRR Dadri	8.9.11/12 Noon	10.10.11	KUK
4	Swimming & Waterpolo	7 to 9.9.11	MDU Rohtak	During Compt.	10.10.11	Kolkata
5	Netball (M)	10 to 12.9.11	NRSGC, Rohtak	12.9.11/11.30am	10.10.11	GGDU, Bilaspur
6	Football (M)	6 to 12.9.11	Ahir, Rewari & G.C. B.Garh	13.9.11/10 am	30.9.11 (NZ) 15.10.11 (IZ)	PTU, Jalandhar
7	Netball (W)	13 to 15.9.11	KMW Kharkhauda	15.9.11/ 11.30 am	10.10.11	GGDU, Bilaspur
8	Basketball (W)	20 to 23.9.11	MKJKM Rohtak	23.9.11/ 12 noon	7.11.11	KUK
9	Pistol Shooting & Rifle Shooting(M&W)	3 & 4.10.11 M & 5.10.11 W	MDU Rohtak	During Compt.	17.10.11	Jiwaji Uni., Gwalior
10	Cricket (M)	1 to 6.10.11	MDU Rohtak	7.10.11 / 9.00 am	15.11.11	Banasthali
11	Badminton (M & W)	5 to 7.10.11	MDU Rohtak	7.10.11 / 1.30 pm	NZ 2.11.11 IZ 28.11.11	PTU, Jalandhar MLS, Udaipur
12	Boxing (M & W)	5 to 7.10.11 & 7 & 8.10.11	-do-	7&8.10.11 / 10 am	14.11.11	BU, Bhopal
13	Volleyball (W)	7 to 9.10.11	DCS Edu. Gohana	9.10.11 / 12.30 pm	10.11.11	YSP Uni., Solan
14	Kabbadi (M)	5 to 9.10.11	MDU, Rohtak	9.10.11 / 1.30 pm	25.10.11 NZ 25.11.11 IZ	YS Parmar Salem
15	Judo (M & W)	15.10.11 M 16.10.11 W	MDU, Rohtak	15.10.11 / 11.30 am 16.10.11 / 11.30 am	14.11.11	TMV, Pune
16	Kho Kho (M)	15 to 17.10.11	L.N. Hindu, Rohtak	15.10.11 / 1.30 pm	15.11.11	SRTM, Nanded
17	Archery (M & W)	20.10.11 M 21.10.11 W	MDU, Rohtak	20-21.10.11	10.11.11	Pbi. Uni., Patiala
18	Chess (M)	20 to 22.10.11	Vaish Coll. Rohtak	22.10.11 / 11 am	27.11.11	VIT Vellor
19	Football (W)	22 to 24.10.11	GC (W) Rohtak	24.10.11 / 1.30 am	5.11.11	Annamalai
20	Lawn Tennis (M)	25 & 26.10.11	MDU, Rohtak	26.10.11 / 1.30 pm	30.11.11 IZ	Manipal Uni.
21	Base Ball (W)	29 to 31.10.11	H.G.C. Sonipat	31.10.11 / 11.30	26.11.11	Cuttack
22	Cricket (M)	20.10.11 to 2.11.11	V.C. Rohtak, Z-A G.C. BWN Z-B KLP RWR, Z-C DGC, GGN, Z-D	3.11.11 / 9.00 am	10.12.11 IZ	VTU, Dehradun BHU, Varanasi
23	Baseball (M)	2 to 4.11.11	MDU, Rohtak	4.11.11 / 11.30 am	26.11.11	Cuttack
24	Korfball	4 & 5.11.11	MDU, Rohtak	5.11.11 / 1.30 pm		Vacant
25	Handball (M & W)	5 to 7.11.11 M 8 to 10.11.11W	MDU, Rohtak	7.11.11 / 2 pm M 10.11.11/2 pm W	10.12.11 IZ	PU, Chandigarh
26	Hockey (W)	5 to 8.11.11	-do-	8.11.11 / 12 noon	20.12.11 IZ	Vacant
27	Athletics (M & W)	7 to 9.11.11	-do-	During Compt.	17.12.11	Bangalore
28	Wrestling (M & W)	10 & 11.11.11 12 & 13.11.11	Govt. College, Faridabad	11.11.11 / 12.30 M 13.11.11 / 12.30 W	10.12.11	CDLU, Sirsa
29	Hockey (M)	15 to 18.11.11	Jat Coll. Rtk.	18.11.11 / 2 pm	20.12.11 IZ	Vacant
30	Softball (M)	1 to 4.12.11	-do-	4.12.11 / 9 am	25.12.11	PU, Chandigarh
31	Softball (W)	4 to 6.12.11	GC (W) Rohtak	6.12.11 / 9 am	25.12.11	- do -
32	Gymnastics (M & W)	5.12.11 M 6.12.11 W	DAV Cent. Faridabad	During Comt.	25.12.11	GNDU, Amritsar
33	Tabel Tennis (M & W)	6 & 7.12.11M 8 & 9.12.11W	Vaish College Engg. Rtk.	7.12.11 / 2 pm M 9.12.11 2 pm W	9.1.12 IZ	RTM, Nagpur
34	Power Lifting (M)	15 & 16.12.11	MDU, Rtk.	During Compt.	19.1.12	Vacant
35	Weight Lifting (M)	18 & 19.12.11	- do -	- do -	- do -	-do-
36	Best Physique (M)	20.12.11	- do -	- do -	- do -	-do-
37	Power Lifting (W)	21.12.11	- do -	- do -	- do -	-do-
38	Weight Lifting (W)	22.12.11	- do -	- do -	- do -	-do-
39	Basketball (M)	15 to 17.12.11 19 & 20.12.11	Aggr. Bilgarh Z-B MDU Rtk (UTD) Z-A	21.12.11 / 2 pm	26.1.12 IZ	Raj. Uni., Jaipur
40	Squash Racket (M)	20 & 21.12.11	MDU, Rtk.	21.12.11 / 12 noon	2nd Week of Jan. 12	Pune
41	Taekwando (M & W)	15 & 16.12.11 M 17 & 18.12.11 W	MDU, Rtk	16.12.11 / 11.30 M 18.12.11 / 11.30 W	25.2.12	Imphal
42	Volleyball (M)	5 to 9.1.12	G.C. Bhiwani	9.1.12 / 2 pm	NZ IZ 10.2.12	MJP, Rohillkhand Bareilly
43	Kabaddi (M) HS	5 to 7.2.12	Jat Coll. Rtk	---	---	---
44	Kabaddi(W) HS	8 to 10.2.12	VMM, Rohtak	---	---	---
45	Yoga (M & W)	15 & 16.2.12	MDU, Rohtak	---	---	---
46	Relay Races (M)	19.2.12	- do -	---	---	---

Abbreviations :  
 1. M stands for Men Section.  
 2. W stands for Women Section.  
 3. HS stands for Haryana Style.  
 4. NS stands for National Style.

Ph. No. : 01262-219305  
 01262-393126  
 (Resi) : 01262-218087  
 Mobile : 09355235911

*(Dr. D. S. Dhull)*  
 Secretary, MDUS  
 Director Sports, M.D.U., Rohtak



MAHARSHI DAYANAND UNIVERSITY  
SPORTS COUNCIL

ANNUAL PROGRAMME

2011-12

MAHARSHI DAYANAND UNIVERSITY  
ROHTAK

## **INDEX**

<b>Sr. No.</b>	<b>Particulars</b>	<b>Page</b>
1.	Letter to Principals/Directors for Organizing Tournaments	1
2.	Letter to Principals for Services of Faculties	2
3.	Fixtures	3
4.	Sports Calendar for the session 2011-12	34
5.	The Selection Trials of the University teams will be held as per schedule	36
6.	Formation of Club Committee of Various Games	39
7.	Rates for Officiating Charges for Inter-College and Inter-University Tournaments.	51
8.	Tentative Number of Officials Approved for Conduct of University Fixtures in Different Games in Each Section	52
10.	Event According to the Weight Categories	54
12.	List of LPE's DPE's And Other	55
13.	General Instructions	57
14.	ANNEXURES	58

## Letter to Principals/Directors for Organizing Tournaments

To

The Principals/ Directors of the concerned  
Colleges/ Institutions of Inter College (M&W) Tournaments  
for the Session 2011-12.

### **Sub:- Organising of Zonal / Inter zonal/ Inter college tournaments.**

Respected Sir/Madam,

1. Your college/ institution has been given the responsibility to conduct the zonal/ inter zonal/ inter college tournament(s) for the session 2011-12 mentioned in the fixture(s) which are given in the Calendar/ Booklet.
2. You are further requested kindly to be present at the venue of the tournament when the tournament is in progress to ensure that the tournament is being conducted in calm and worthy atmosphere and discipline is also maintained. Suitable lodging arrangements for outsider teams and the officials may kindly be made.
3. The performa 'C' must be duly filled in and signed by the Manager of the team and Org. Secy. of the tournament.
4. Kindly send the detailed results along with the organizing secretary report after the completion of the tournament so that the Press note could be sent in time to the newspapers and the certificates could be prepared well in time. Prescribed performa'A' is printed in the booklet at page No. 58. Also please collect the eligibility performas duly checked by the undersigned and valid identity cards before the commencement of the match to ensure that the playing members are actually eligible and teams which are not in possession of checked eligibility performas and I-cards be not allowed to participate in the tournament.
5. It is further added that particulars of each team member must be obtained in the performa'B' before the start of every match . Performa 'B' is printed at page No.60. These filled performas are to be kept by you until the same are demanded by this office in case of any protest/dispute.
6. Particulars of the teams completing for 1st, 2nd, 3rd and 4th positions of the university must be obtained in performa 'C' and the same are handed over to the Secretary or his nominee who shall be present at the time of final match. Kindly note the above instructions. Your kind cooperation is solicited, please.

Yours faithfully,



Secretary, MDUSC, Rohtak

**Please see:-** Payment of TA/DA and Umpiring charges is to be made as per the rules printed in the HBI of rules and regulations of MDUSC, Rohtak.

## Letter to Principals for Services of Faculties

To

The Principals of the concerned Colleges /  
Heads of various Departments/  
Institutions of the M.D. University, Rohtak.

Sub:- Services of the Faculties.

Sir/Madam,

Faculties of your College/ Department/ Institution (list attached) have been nominated as Chairman, Secretary & Member(s) on various selection committees of MDUSC, Rohtak to select the university teams for participation in the North Zone/ North East Zone/ All India Inter University Tournaments for the session 2011-12. The services of the faculties will be required from time to time for the selection of the university teams. Their services may kindly be made available for this office as per schedule given in the sports calendar booklet. Their TA/DA and remuneration charges, if any, will be paid to them out of MDUSC funds as per university rules.

Yours sincerely,



Secretary,  
MDUSC, Rohtak.



# FIXTURES



## KHO-KHO (WOMEN)

Venue : Vaish Mahila College, Rohtak

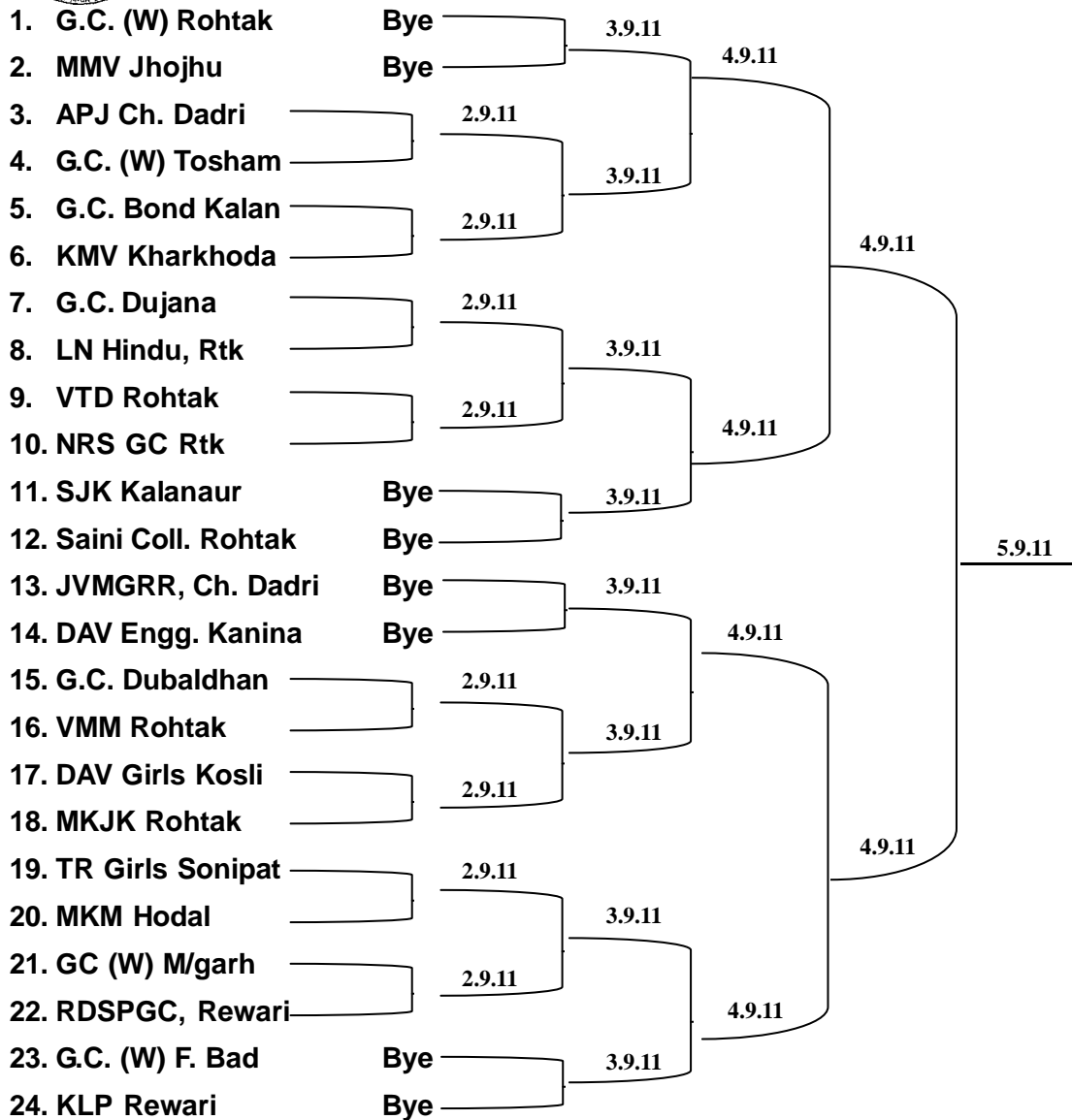

1. Illrd place match will be played on 5.9.11 at 9. a.m.
2. Selection trials will be held on 5.9.11 at 11 a.m.
3. Officials will be appointed by the Org. Secretary.



# KABBADI (WOMEN) NS

Venue : JVMGRR, College, Ch. Dadri

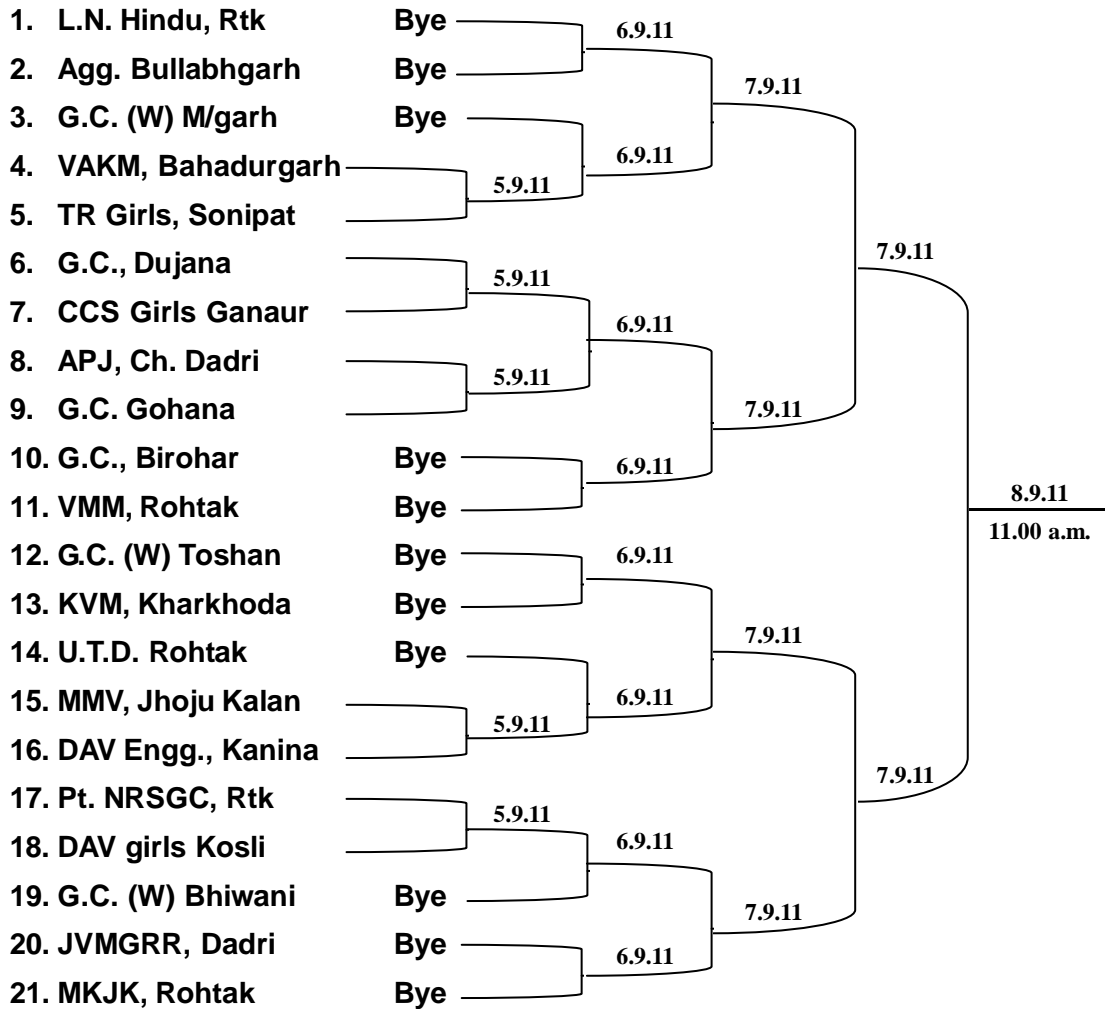

1. Illrd place match will be played at 9. a.m. on 8.9. 11
2. Selection trials on 8.9.11 at 12.00 Noon at JVMGRR College, Ch. Dadri
3. Officials will be appointed by the Org. Secretary.



# NET BALL (MEN)

Venue : Pt. N.R.S. G.C. Rohtak

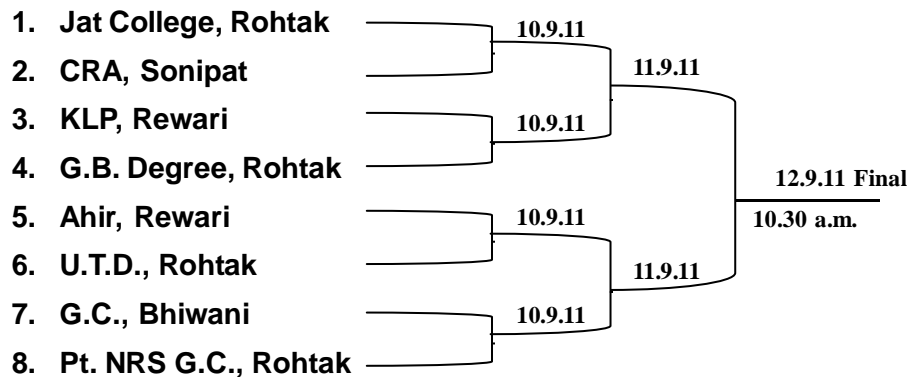

1. Match for Illrd place on 12.9.11 at 8.30 a.m.
2. Selection trials will be held on 12.9.11 at 11.30 a.m.
3. Officials will be appointed by the Org. Secretary.



# FOOTBALL (M)

## Zone 'A' Ahir College, Rewari

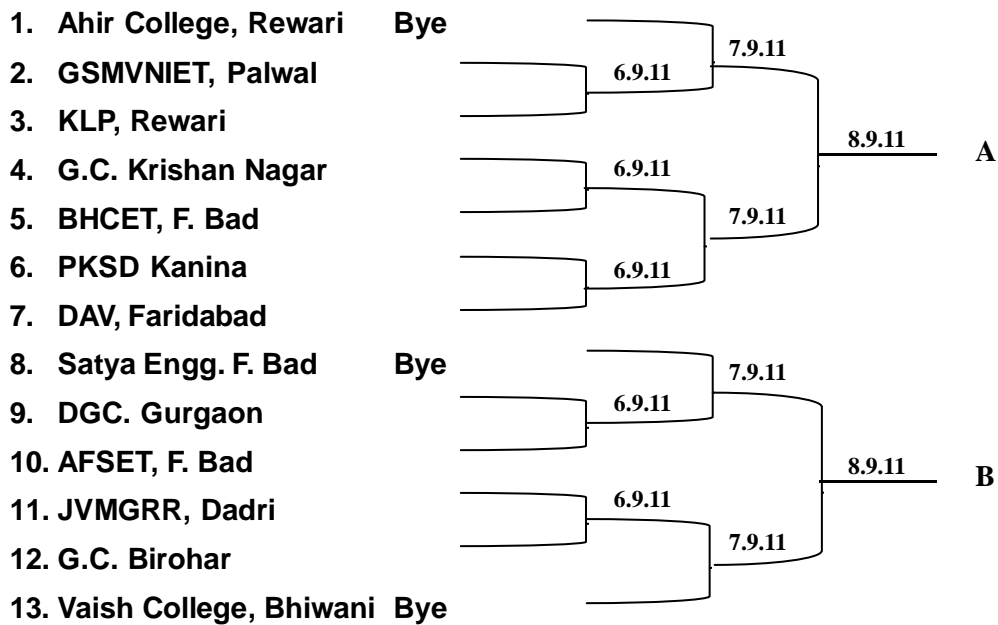

## Zone 'B' G.C. Bahadurgarh

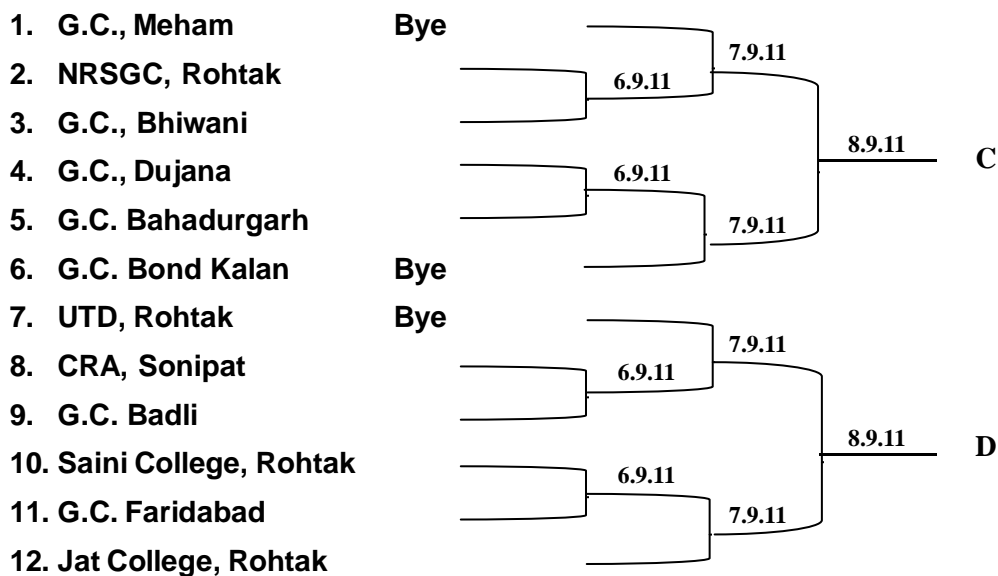

**1. League matches will be played as per fixtures given over leaf**

**1. A      V/s    D      on 10.9.11 at 10.00 a.m.**

**2. C      V/s    D      on 10.9.11 at 1.00 p.m.**

**3. A      V/s    C      on 11.9.11 at 10.00 a.m.**

**4. B      V/s    D      on 11.9.11 at 1.00 p.m.**

**5. A      V/s    B      on 12.9.11 at 10.00 a.m.**

**6. C      V/s    D      on 12.9.11 at 1.00 p.m.**

**2. Selection trials will be held on 13.9.11 at 10.00 a.m.**

**3. Officials for Inter-Zonal will be appointed by this office.**



# NETBALL (WOMEN)

Venue : Kanya Mahavidalya, Kharkhoda

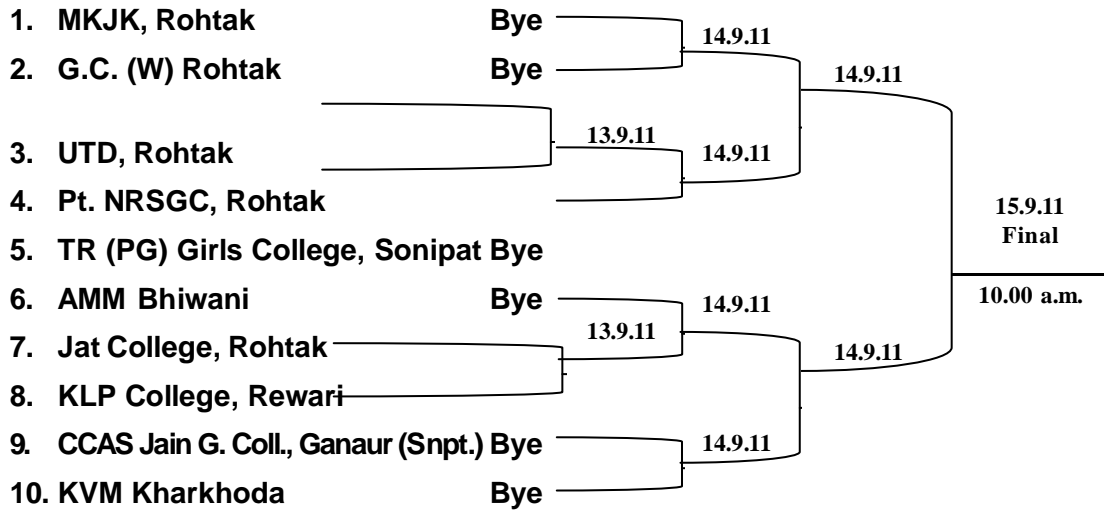

1. Match for Illrd place will be played at 15.9.11 at 8.30 a.m.
2. Selection trials will be held on 15.9.11 at 11.30 a.m.
3. Officials will be appointed by the Org. Secretary.





# BASKETBALL (WOMEN)

Venue : M.K.J.K. College, Rohtak

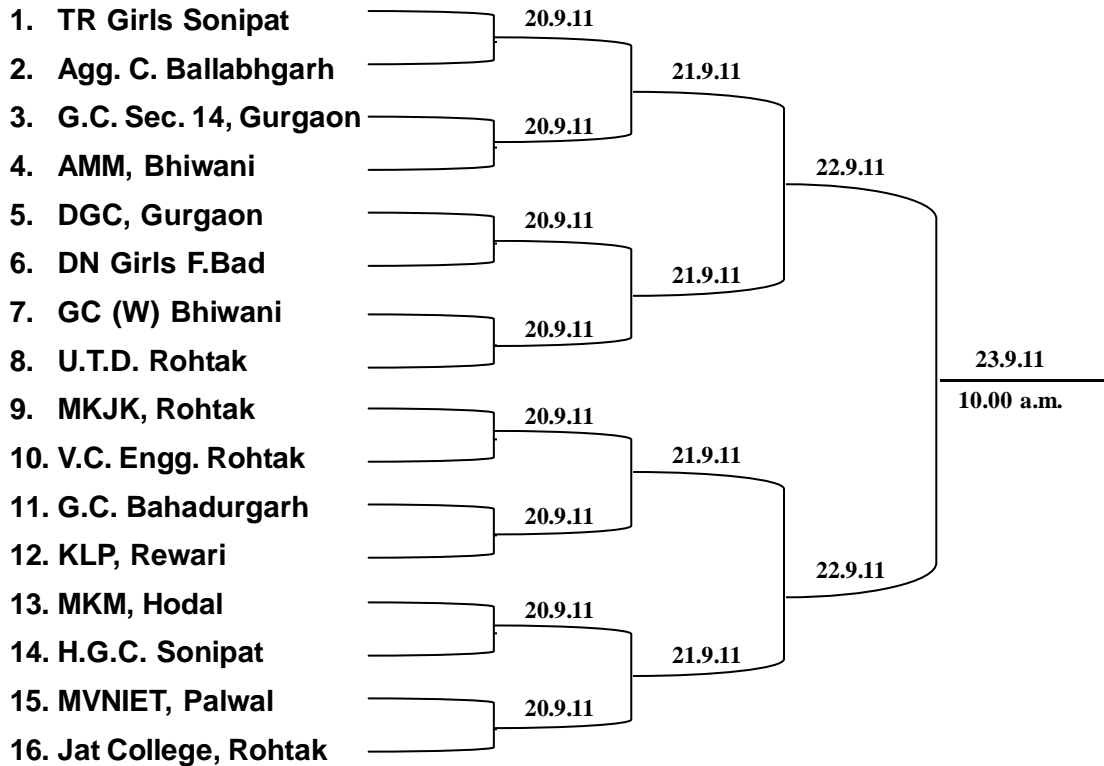

1. Match for Illrd place on 23.9.11 at 9.00 a.m.
2. Selection trials will held on 23.9.11 at 12.00 Noon
3. Officials will be appointed by the Org. Secretary.



# CRICKET (WOMEN)

Venue : MDU Sports Complex, Rohtak

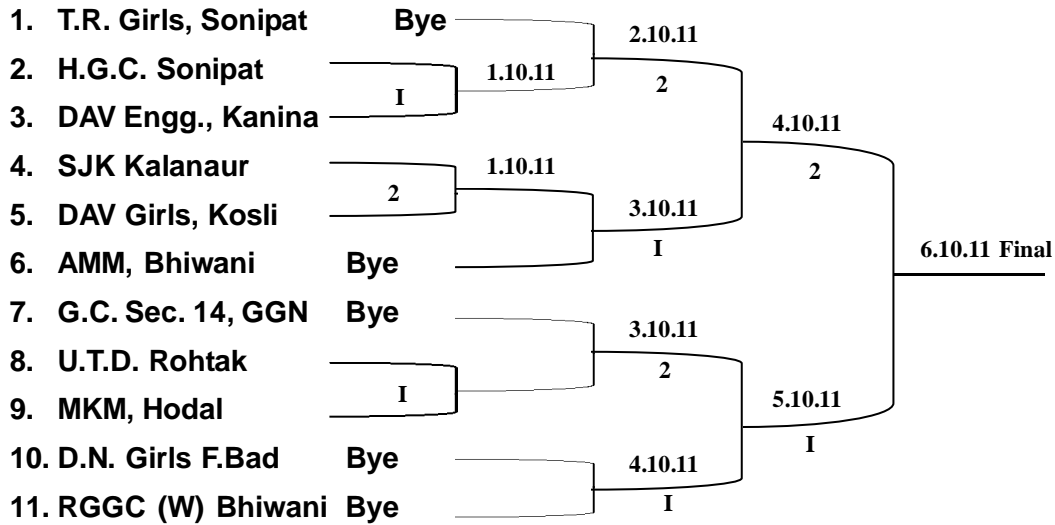

1. Match for Illrd place on 5.10.11 at 9.00 a.m. Ground No. 2.
2. Selection trials will be held on 7.10.11 at 9.30 a.m.
3. Officials will be appointed by the Org. Secretary.



# BADMINTON (MEN)

Venue : MDU Sports Complex, Rohtak

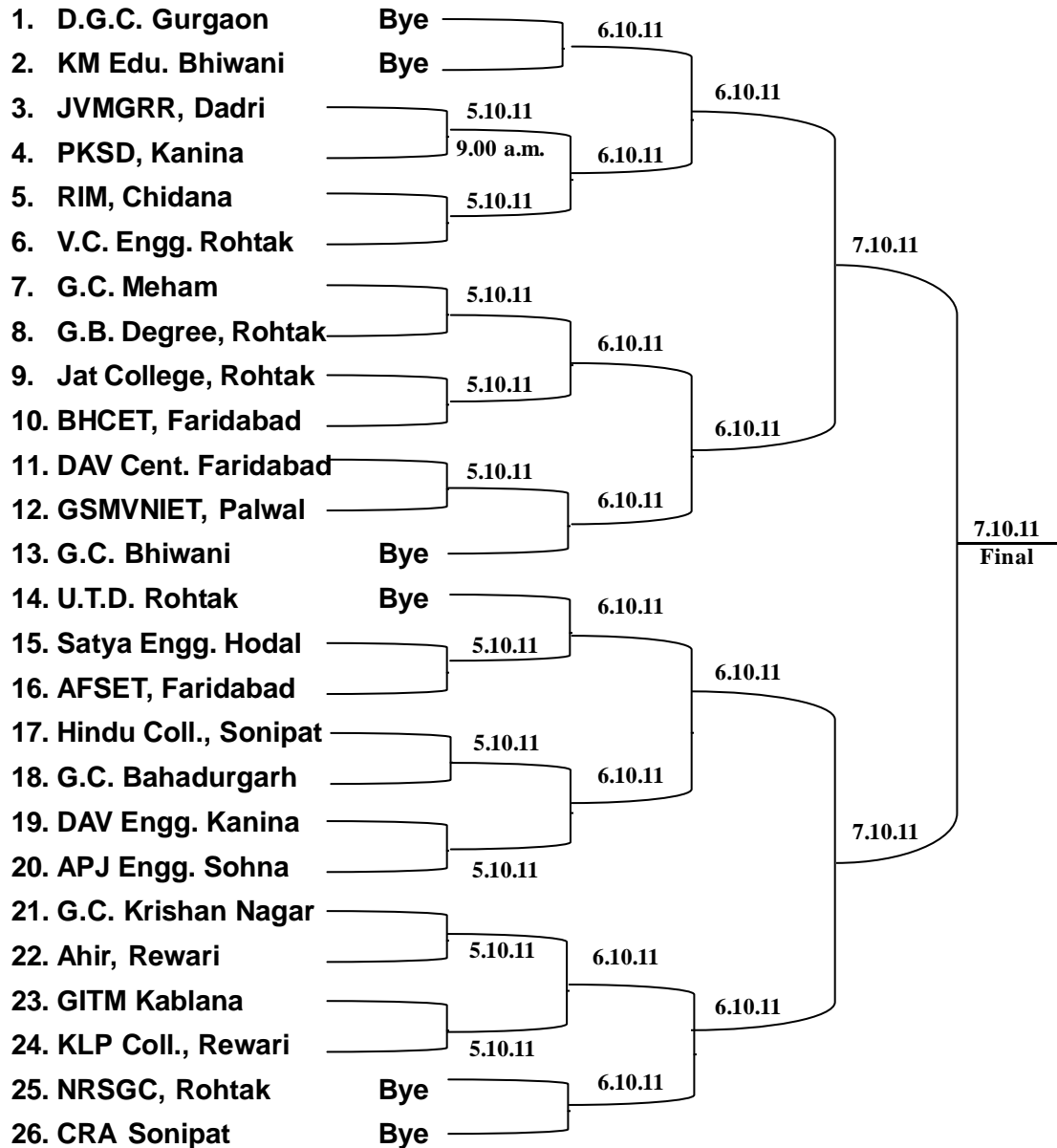

1. Selection trials will be held on 7.10.11 at 1.30 p.m.
2. Match will start from 9.00 a.m. sharp.
3. Officials will be appointed by this office.



# BADMINTON (WOMEN)

Venue : MDU Sports Complex, Rohtak (U.T.D.)

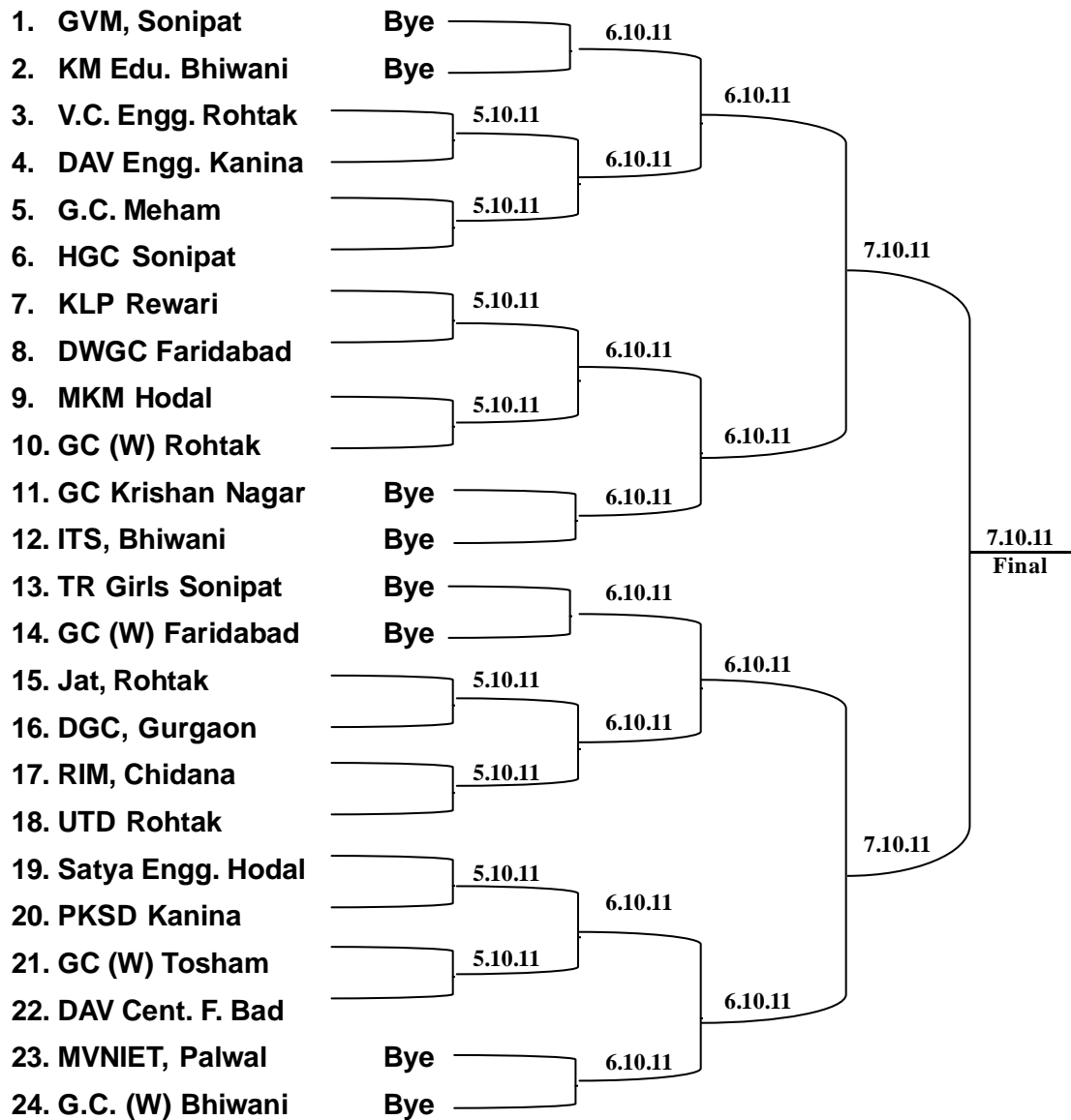

1. Match will starts at 9.00 a.m. sharp.
2. Selection trials will be held on 7.10.11 on 1.30 a.m.
3. Officials will be appointed by this office.



# VOLLEYBALL (WOMEN)

Venue : D.C.S. College of Education, Gohana

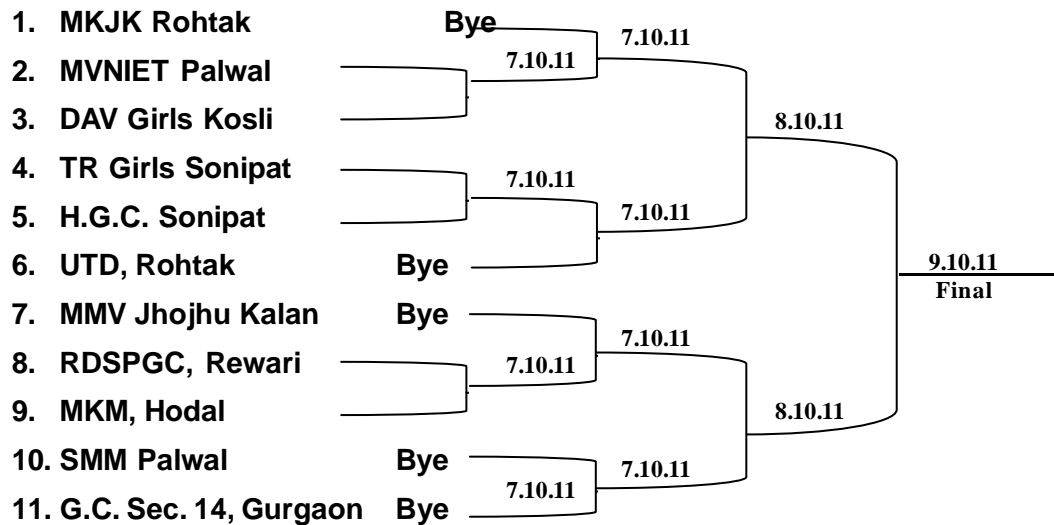

1. Match for Illrd place will be placed on 9/10 at 9.00 a.m.
2. Selection trials will be held on 9/10 at 12.30 p.m.
3. Officials will be appointed by the Org. Secretary.



# KABADDI (MEN) NS

Venue : MDU Sports Complex, Rohtak (U.T.D.)

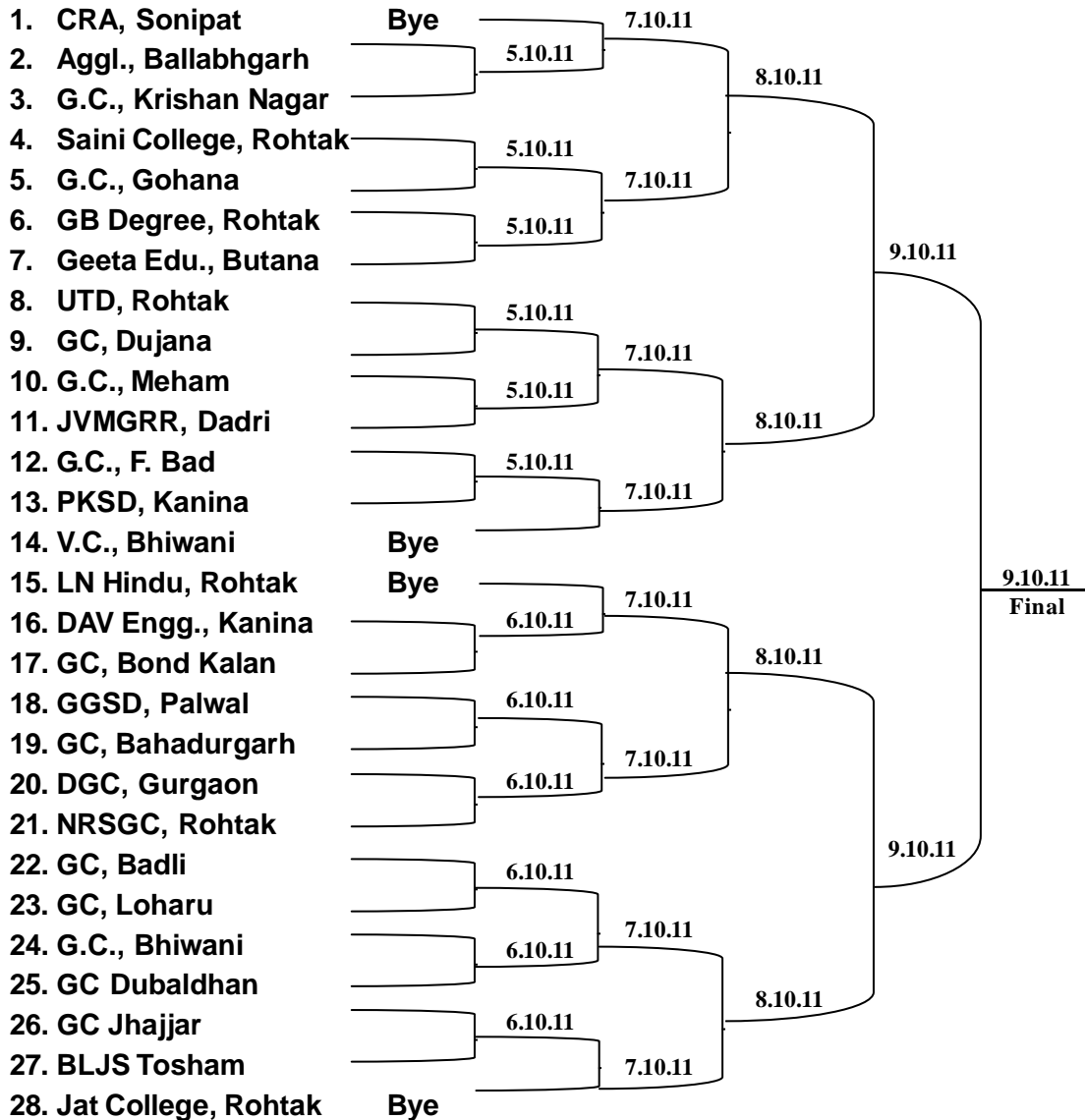

1. Selection trials will be held on 9.10.11 at 1.30 p.m.
2. Officials will be appointed by this office.
3. Matches will start at 9.00 a.m. sharp every day. All the teams are directed to report at the above mentioned time strictly.





# KHO-KHO (M)

Venue : L.N. Hindu College, Rohtak

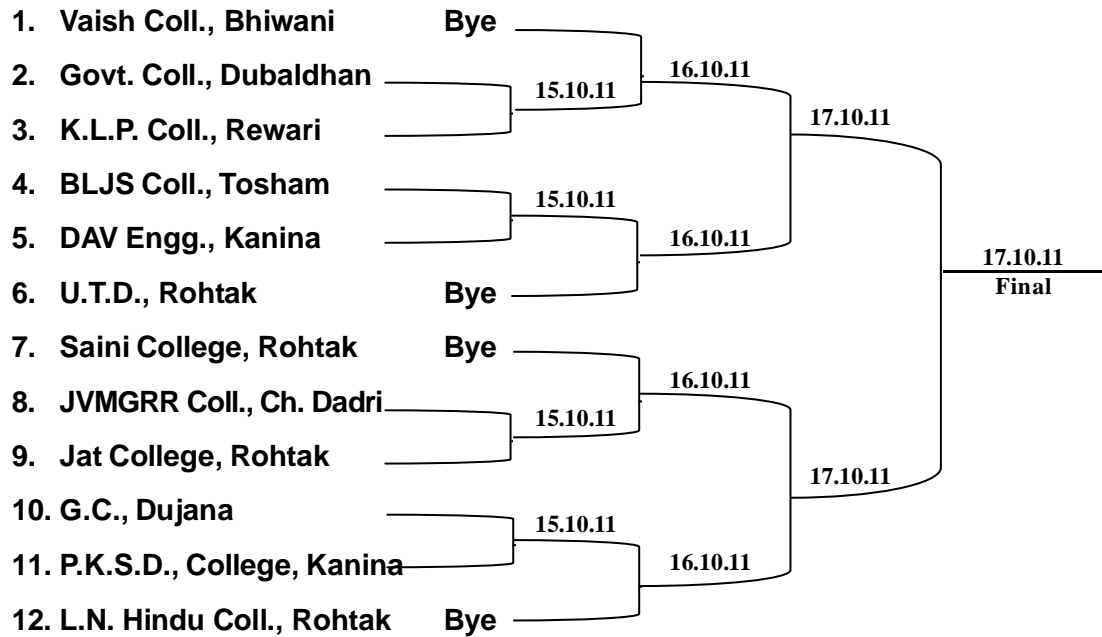

1. Match will starts from 10.00 a.m. sharp everyday.
2. Selection trials on 17.10.11 at 1.30 p.m.
3. Officials will be appointed by the Org. Secy.



# FOOTBALL (W)

Venue : Govt. (W) College, Rohtak

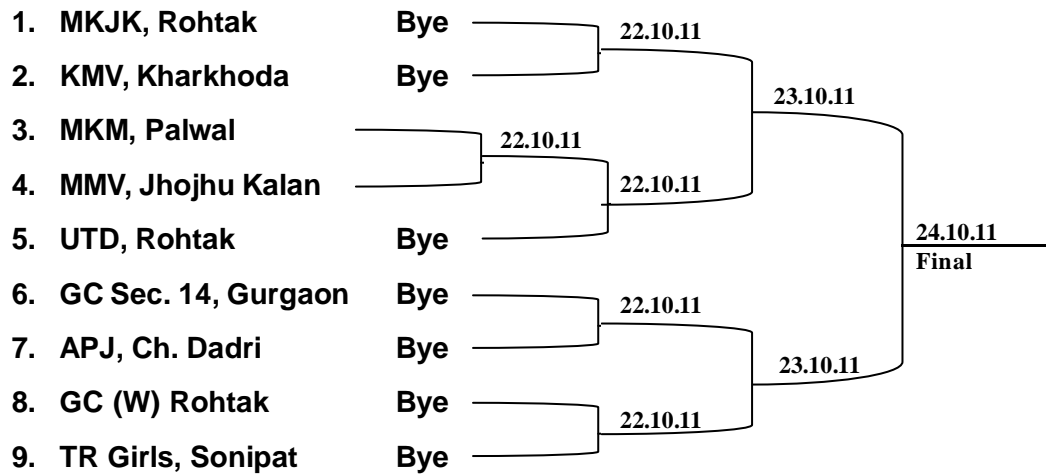

1. Matches will start at 9.00 a.m. everyday.
2. Selection trials will be held on 24.10.11 at 2.00 p.m.
3. Officials will be appointed by the Org. Secretary.



# BASEBALL (W)

Venue : Hindu Girls College, Sonipat

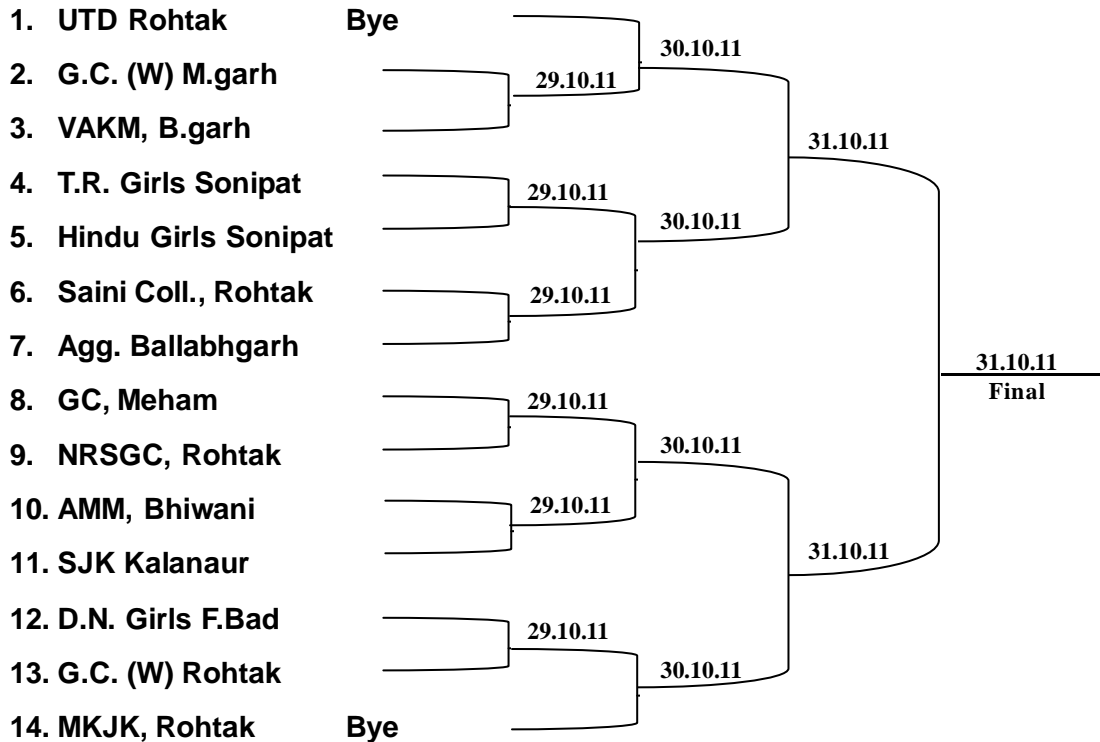

1. Selection trials will be held on 31.10.11 at 11.30 a.m.
2. Officials will be appointed by this office.
3. The matches will start at 9.00 a.m. everyday. The teams are required to report at 8.30 a.m. sharp.
4. Without proper Kit no team will be allowed to participate in the tournament.



# CRICKET (M)

## Zone 'A' Vaish College, Rohtak

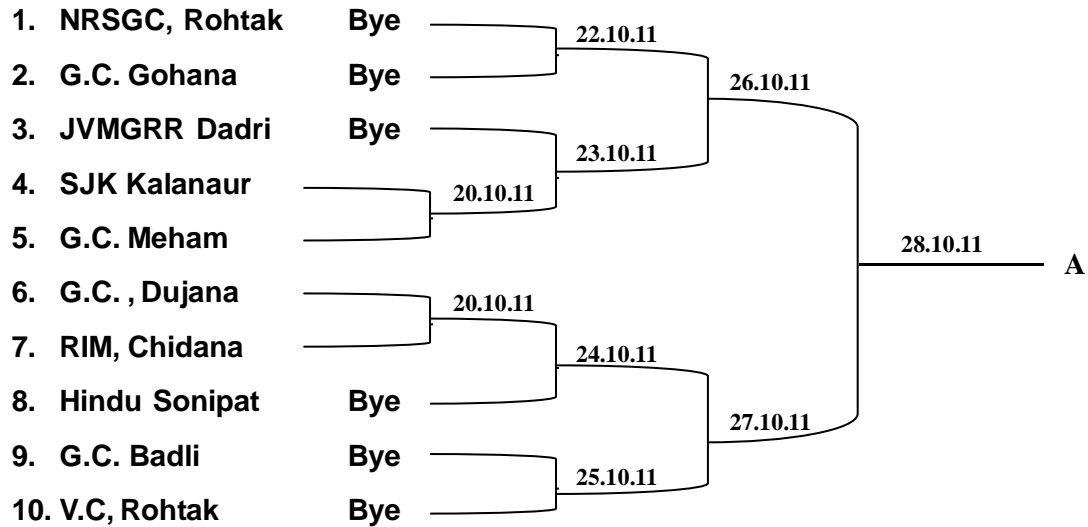

## Zone 'B' MDU. Sports Comple, Rohtak

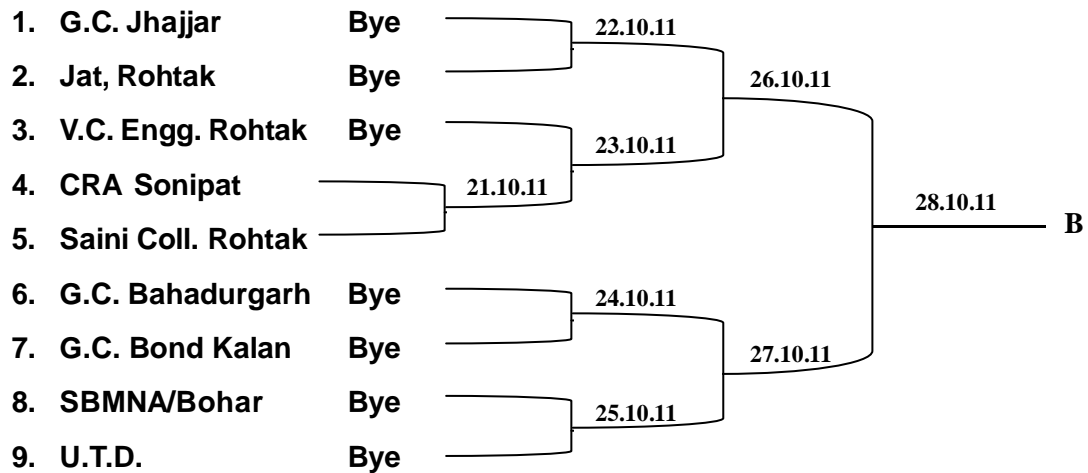

### Zone 'C' Govt. College, Bhiwani

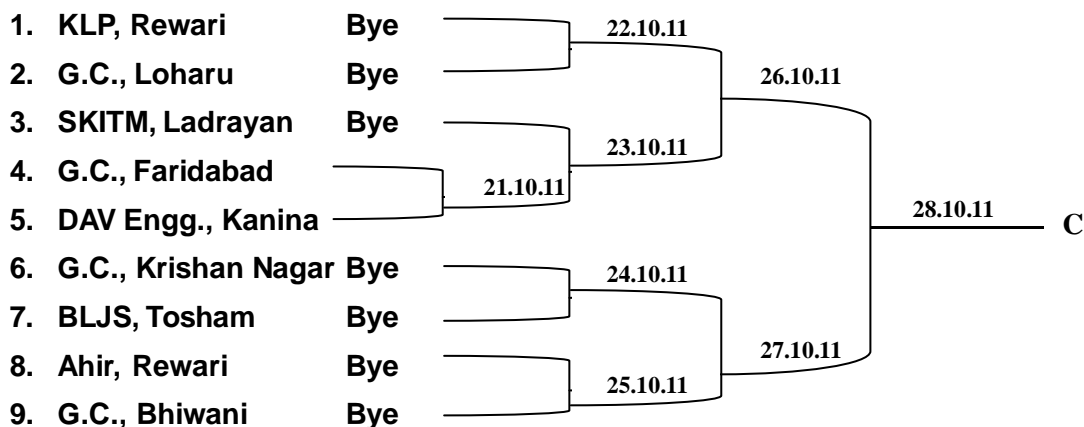

### Zone 'D' Govt. College, Gurgaon

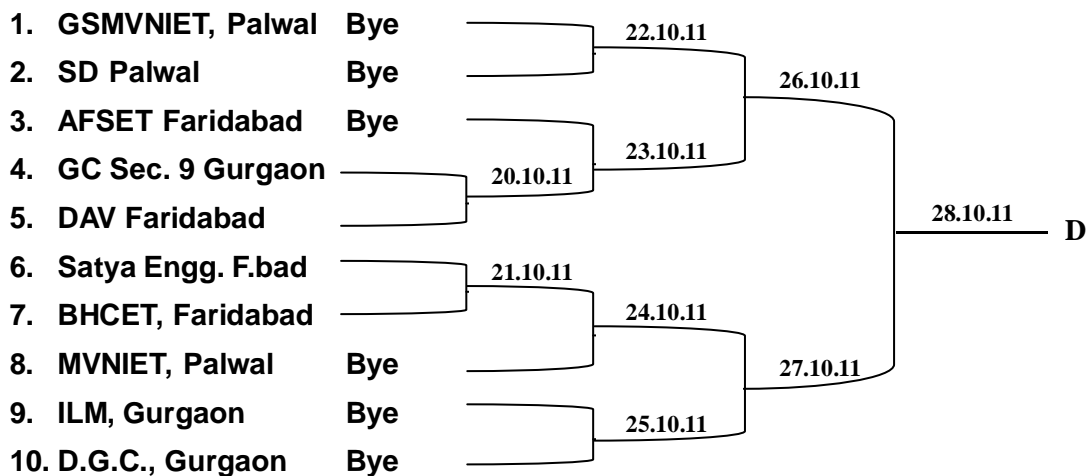

I. League matches will be played at MDU Sports Complex as per fixtures given below :

1. A v/s D on 30.11 at 9.00 a.m.
2. B v/s C on 30.11 at 9.00 a.m.
3. A v/s C on 31.11 at 9.00 a.m.
4. B v/s D on 31.11 at 9.00 a.m.
5. A v/s B on 1.11 at 9.00 a.m.
6. C v/s D on 1.11 at 9.00 a.m.

Note : Trials on 2.11.10 starting from 9.00 a.m.



# BASEBALL (M)

Venue : M.D.U., Rohtak

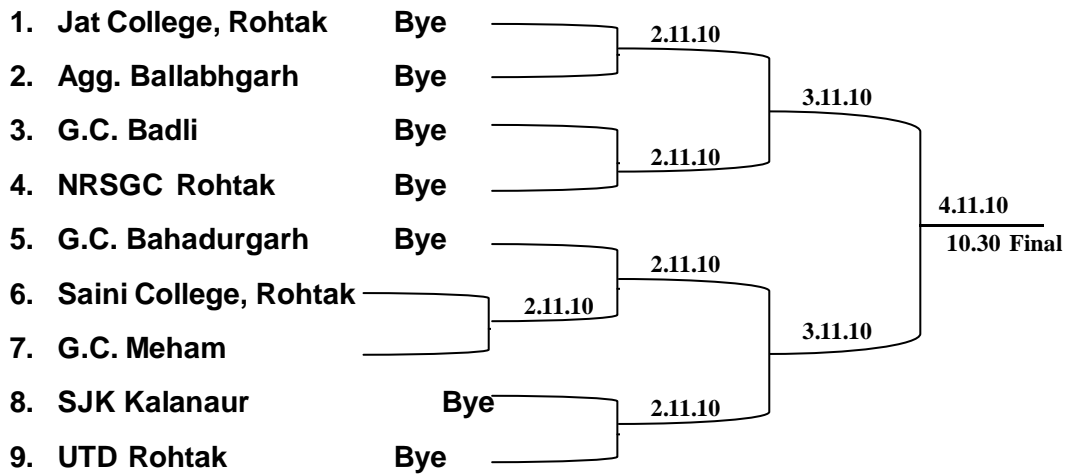

1. Match for Illrd place will be played on 4.11.10 at 9.00 a.m.
2. Selection trials will be held on 4.11.10 at 11.30 p.m.
3. Officials will be appointed by this office.





# KORFBALL

Venue : MDU Sports Complex, Rohtak (U.T.D.)

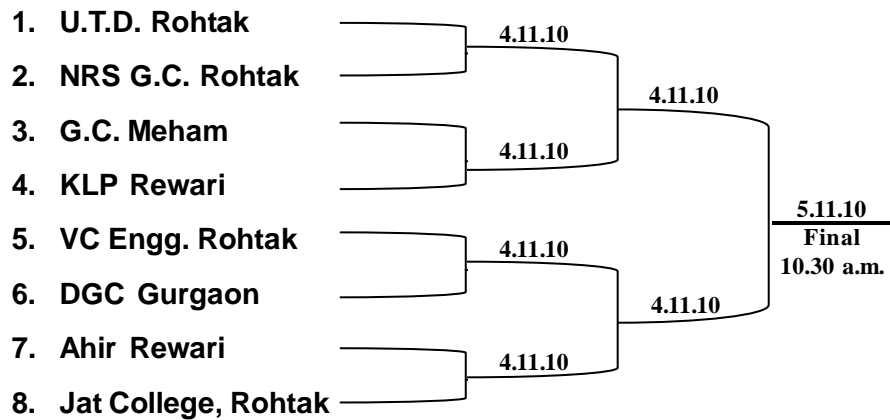

1. Illrd place Match will be played on 5.11.10 at 9.00 a.m.
2. Selection trials will be held on 5.11.10 at 12.30 p.m.
3. Identity Cards for E.P. will be submitted to the Org. Secretary.



# HAND BALL (M)

Venue : MDU Sports Complex, Rohtak (U.T.D.)

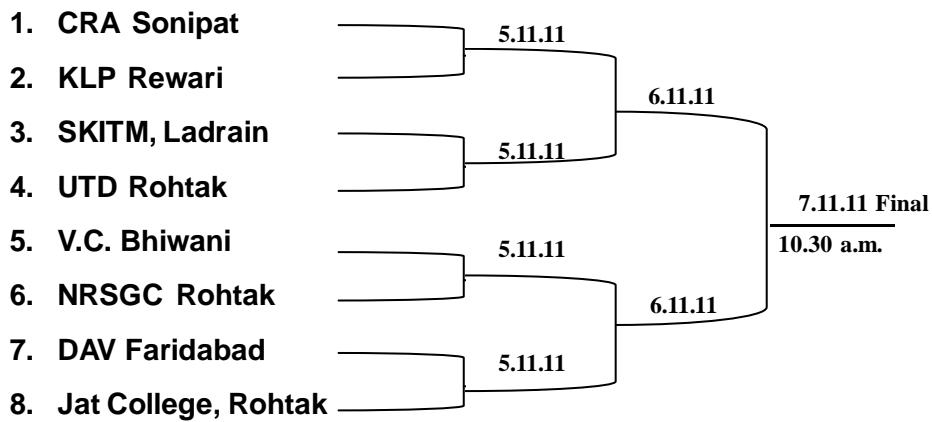

1. Match for Illrd place will be played on 7.11.11 at 9.00 a.m.
2. Selection trials will be held on 7.11.11 at 12.30 p.m.
3. Officials will be appointed by this office.



# HAND BALL (W)

Venue : MDU Sports Complex, Rohtak

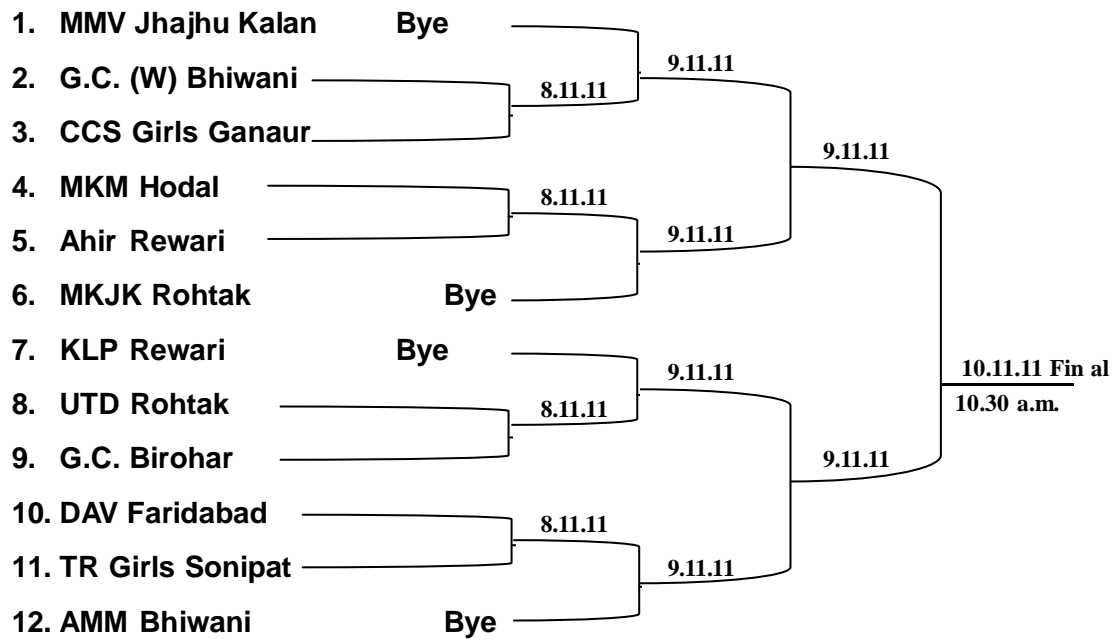

1. Match for Illrd place will be played on 10.11.11 at 9.00 a.m.
2. Selection trials will be held on 10.11.11 at 12.30 p.m.
3. Officials will be appointed by this office.



# HOCKEY (W)

Venue : G.C., Sec. 14, Gurgaon

1. G.C. Sec. 14, Gurgaon	}	5.11.11	A
2. G.C. (W) Bhiwani			
3. H.G.C. Sonipat	}	5.11.11	B
4. MKJKM, Rohtak			
5. M.A. G. Coll. Jhajjar	}	5.11.11	C
6. Saini College, Rohtak			
7. TR (PG) G Coll., Sonipat		Bye	D

League Matches will be played as per fixtures given below :

1. A v/s D	on	6/11/11 at 9.00 a.m.
2. C v/s B	on	6/11/11 at 10.30 a.m.
3. A v/s C	on	7/11/11 at 9.00 a.m.
4. B v/s D	on	7/11/11 at 10.30 a.m.
5. A v/s B	on	8/11/11 at 9.00 a.m.
6. C v/s D	on	8/11/11 at 10.30 a.m.

I. Selection trials will be held on 8.11.11 at 12.00 Noon



# HOCKEY (M)

Venue : Jat College, Rohtak

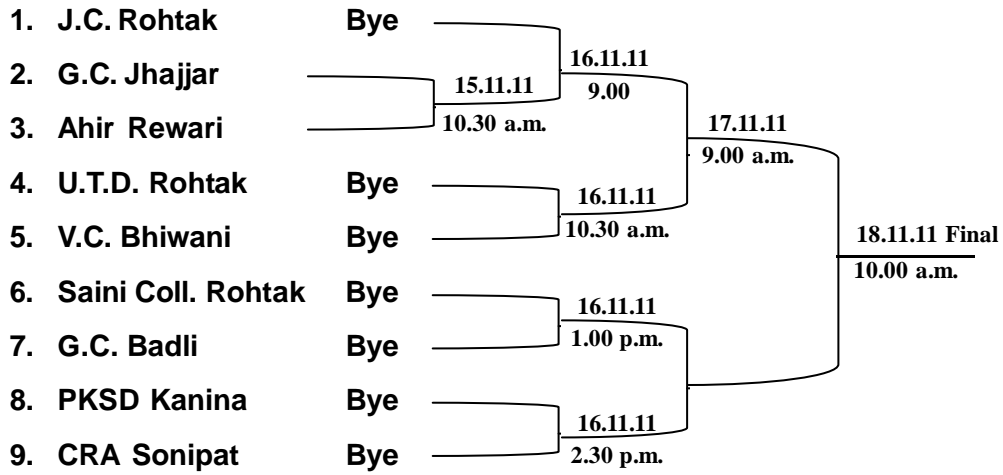

1. Match for Illrd place on 17.11.11 at 12.30 p.m.
2. Selection trials will be held on 18.11.10 at 12.00 Noon



# SOFTBALL (M)

Venue : Jat College, Rohtak

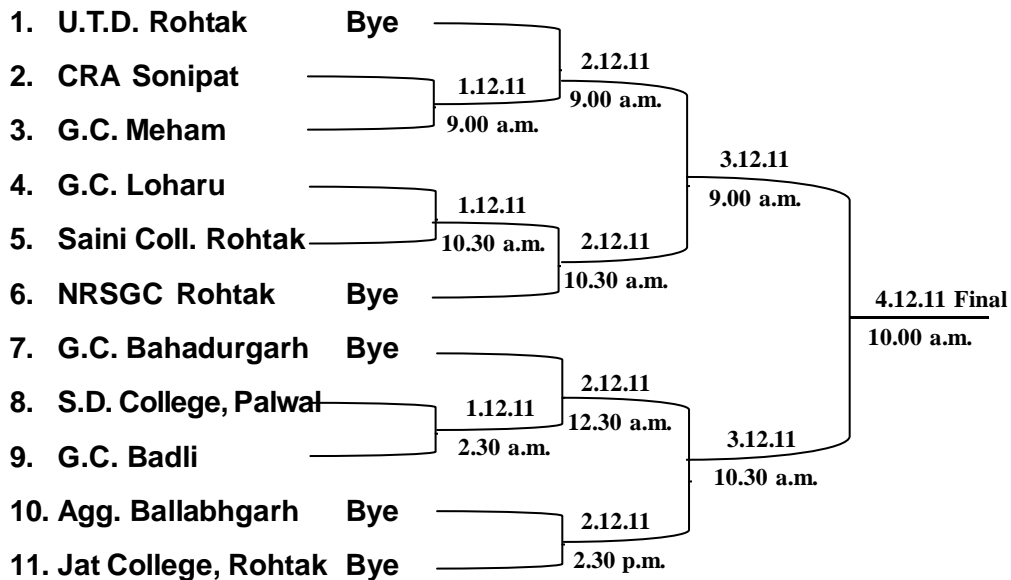

1. Match for Illrd place on 3.12.11 at 2.30 p.m.
2. Selection trials will be held on 4.12.11 at 12.00 Noon
3. Officials will be appointed by this office.





# SOFTBALL (W)

Venue : Govt. (W) College, Rohtak

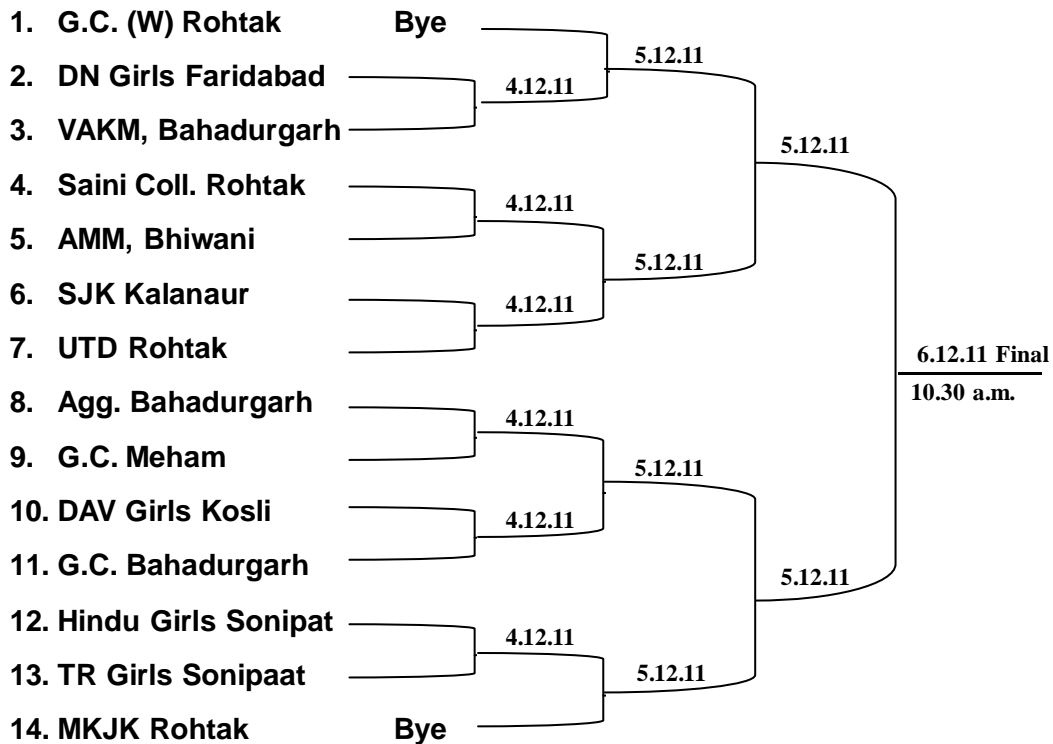

1. Match for Illrd place on 6.12.11 at 9.00 p.m.
2. Selection trials will be held on 6.12.11 at 12.00 Noon
3. Officials will be appointed by this office.



# TABLE TENNIS (MEN)

Venue : Vaish Engg. College, Rohtak

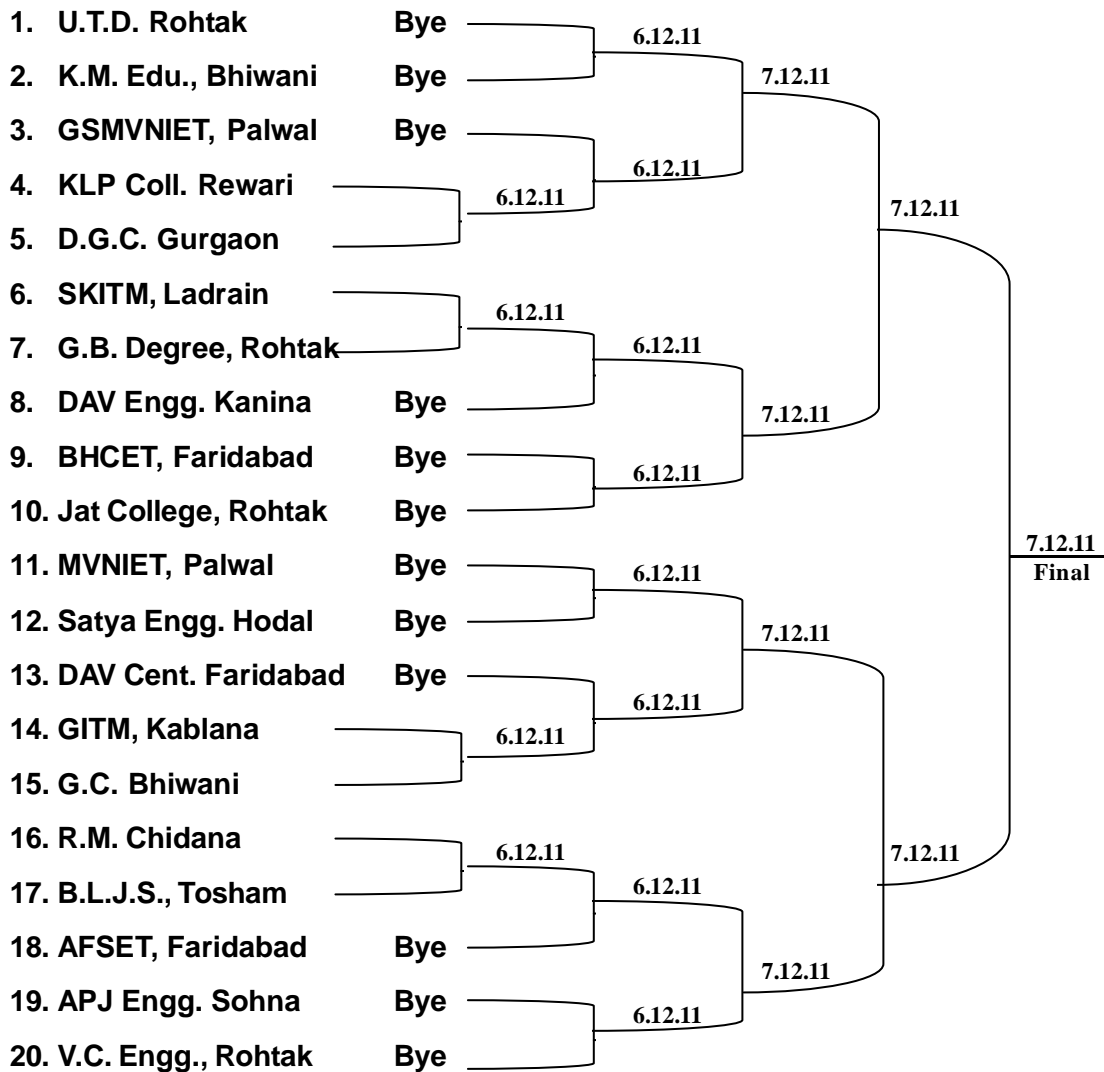

1. Match will at 9.00 a.m. sharp everyday its per schedule.
2. Selection trials will be held on 7.12.11 at 2.00 p.m.



## TABLE TENNIS (W)

Venue : Vaish Engg. College, Rohtak

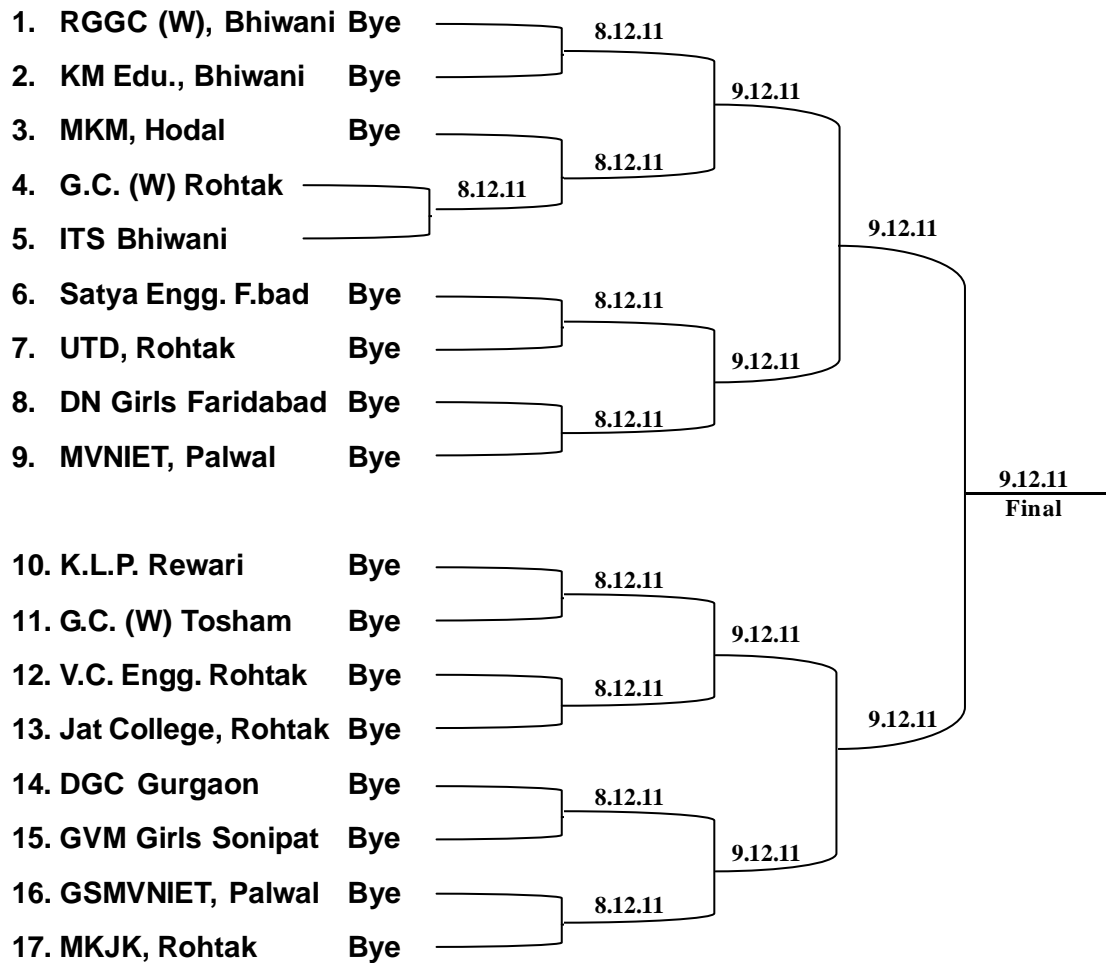

1. Matches will start from 9.00 a.m. everyday as per schedule
2. Selection trials will be held on 9.12.10 at 2.00 a.m.



## BASKET BALL (M)

### Zone 'A' M.D.U., Rohtak (U.T.D. )

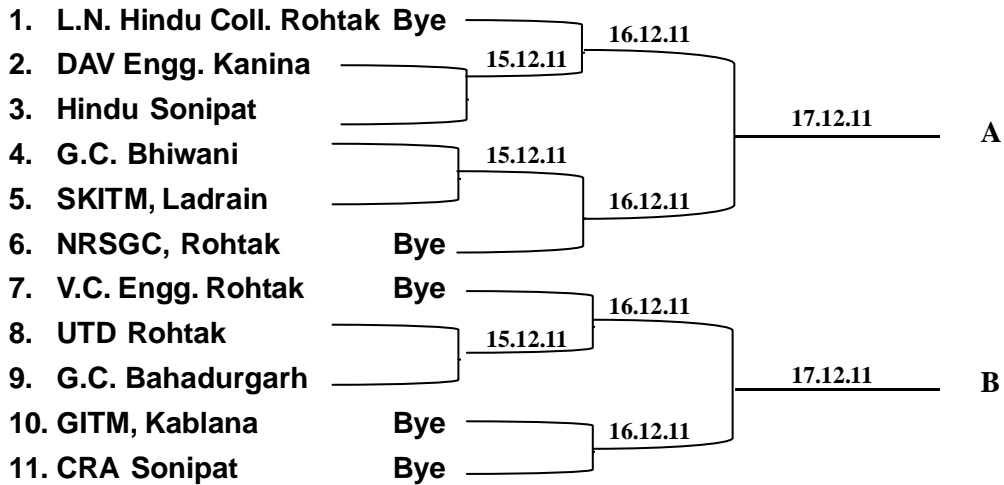

### Zone 'B' Agg. College Ballabhgarh

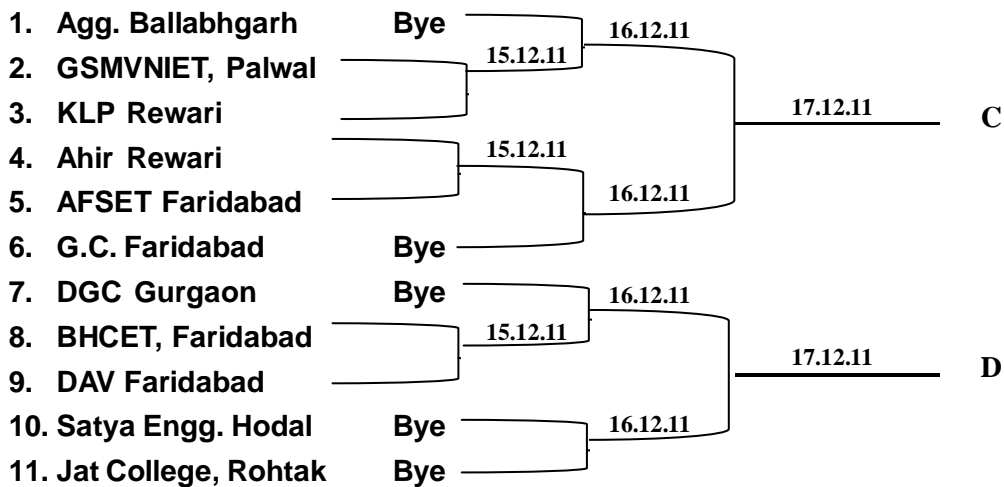

**Note :** Legue matches will be played as per fixture given below :

1. A v/s D on 19.12.11 at 11a.m.
2. B v/s C on 19.12.11 at 12.30
3. A v/s C on 20.12.11 at 11.00
4. B v/s D on 20.12.11 at 12.30
5. A v/s B on 21.12.11 at 9.00 a.m.
6. C v/s D on 21.12.11 at 10.30

**Trials :** on 21.12.11 12.30 p.m. D.C. Edu. Gohana



# VOLLEY BALL (M)

Venue : Govt. College, Bhiwani

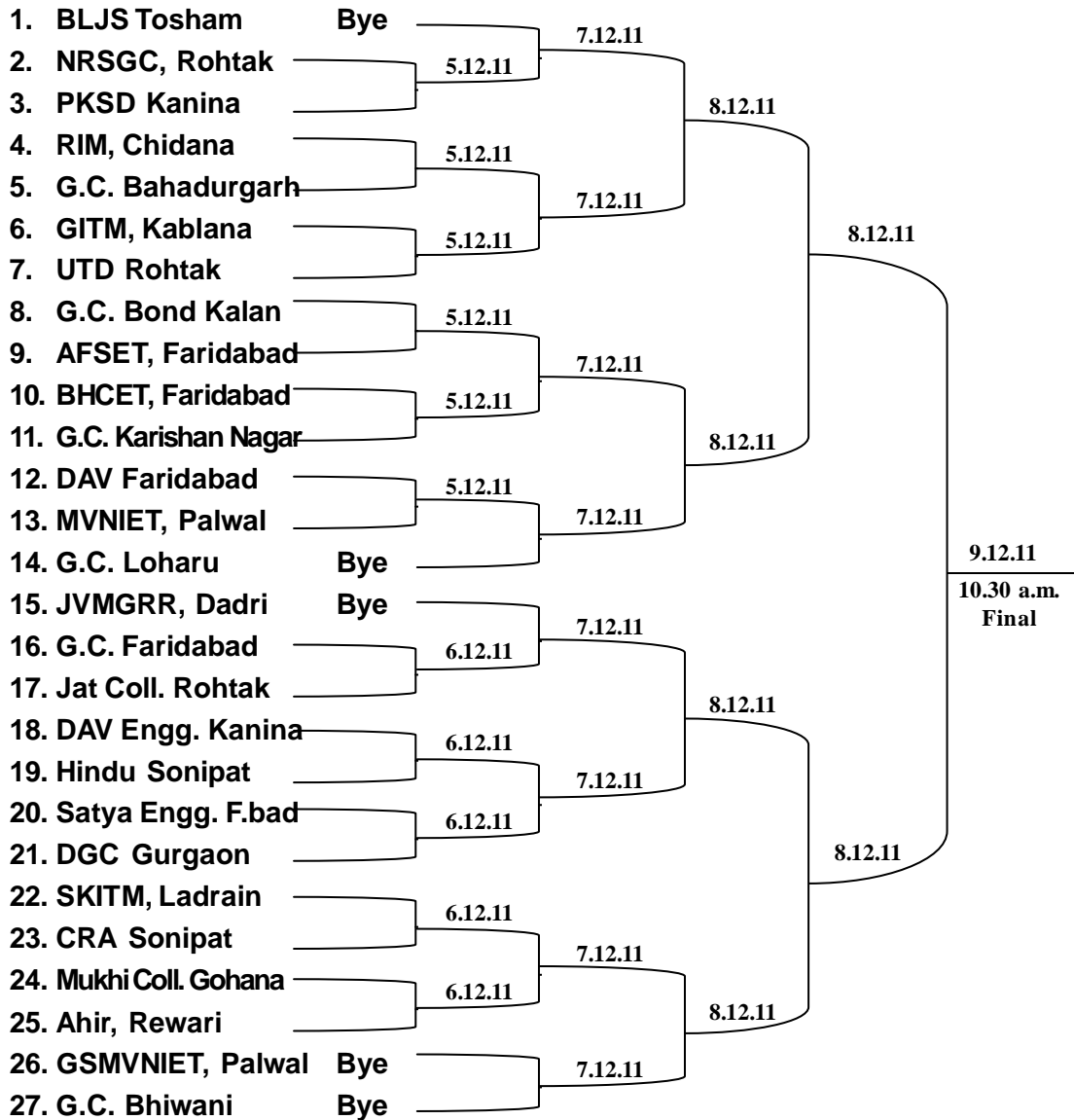

1. Illrd place match will be played on 9.12.11 at 9. a.m.
2. Selection trials will be held on 9.12.11 at 12.30 p.m. at G.C. Bhiwani
3. Officials will be appointed by the Org. Secretary.



# KABADDI (M) H.S.

Venue : Jat College, Rohtak

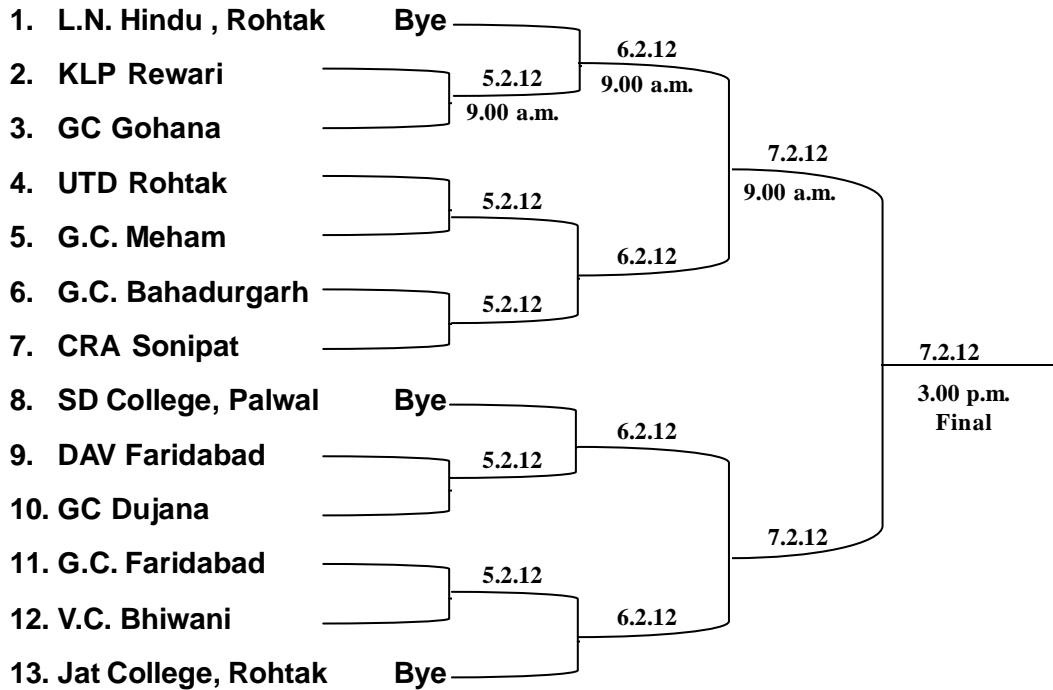

1. Illrd place match will be played on 7.12.12 at 1.30 a.m.
2. Match will start at 9.00 a.m. sharp everyday.



# KABADDI (W) H.S.

Venue : Vaish Mahila College, Rohtak

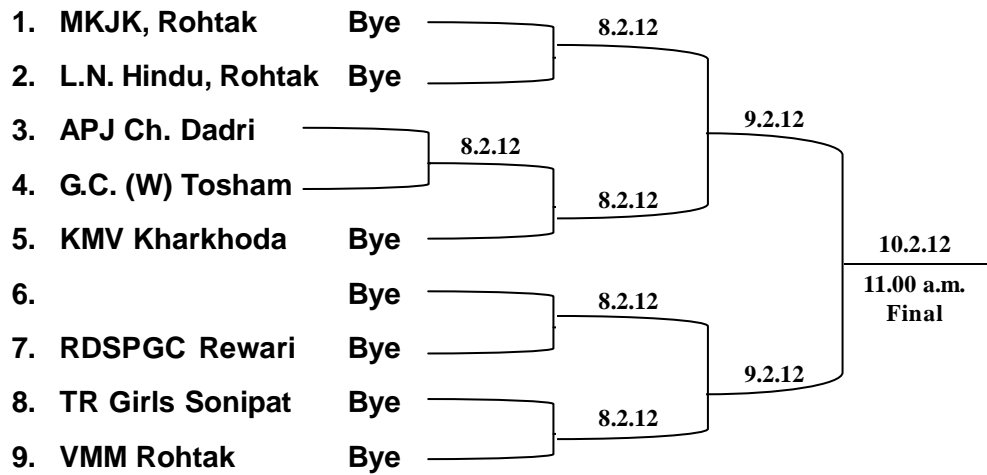

1. Illrd place match will be played on 10.2.12 at 9.30 a.m.
2. Officials will be appointed by the Org. Secretary.

## Sports Calendar for the session 2011-12

Sr. No.	Name of the Game	Date of inter college tournament	Venue of tournament	Date of selection trials	Date of NZ/AIUU Tournament	Venue of the AIUU Tournament
1	Cross Country (M&W)	28.8.2011	MDU Rohtak	28.8.2011	3.10.11	MDU
2	Kho Kho (W)	2 to 5.9.11	VMM Rtk	5.9.11/ 11 am	15.10.11	Mumbai
3	Kabaddi (W)	5 to 8.9.11	JVMGRR, Delhi	8.9.11/ 12 Noon	10.10.11	KUK
4	Swimming & W.Polo	7 to 9.9.11	MDU Rtk	During Compt.	10.10.11	Kolkata
5	Netball (M)	10 to 12.9.11	NRS GC Rtk	12.9.11/ 11.30	10.10.11	GGDU Bilaspur
6	Football (M)	6 to 12.9.11	Zhir, Rewari & G.C.B/Garh	13.9.11/ 10 am	30.9.11 (NZ) 15.10.11 (IZ)	PIU Jalandhar
7	Netball (W)	13 to 15.9.11	KMV Kharkhauda	15.9.11/ 11.30 am	10.10.11	GGDU Bilaspur
8	Basketball (W)	20 to 23.9.11	MKJKM Rtk	23.9.11, 12 noon	7.11.11	KUK
9	Pistol Shooting & R. Shooting (M&W)	3 to 4.10.11 M 5.10.11 W	MDU Rtk	During compt.	17.10.11	Jiwaji Uni. Gwalior
10	Cricket (W)	1 to 6.10.11	MDU Rtk	7.10.11/ 9.00 am	15.11.11	Banasthali
11	Badminton (M&W)	5 to 7.10.11	-eb-	7.10.11/ 1.30 pm	NZ 2.11.11 IZ 28.11.11	PIU Jalandhar MLS Udaipur
12	Boxing (M&W)	5 to 7.10.11 & 7 to 8.10.11	-eb-	7 & 8.10.11 at 10.00 am	14.11.11	BU, Bhopal
13	Volleyball (W)	7 to 9.10.11	DSC Edu, Gohana	9.10.11/ 12.30	10.11.11	YSP Uni. Solan
14	Kabaddi (M)	5 to 9.10.11	MDU, Rtk	9.10.11/ 1.30 pm	25.10.11 NZ 25.11.11 IZ	YS Parmar Salem
15	Judo (M&W)	15.10.11 M 16.10.11 W	MDU Rtk	15.10.11/ 11.30 16.10.11/ 11.30	14.11.11	TMV, Pune
16	Kho Kho (M)	15 to 17.10.11	INHindu, Rtk	15.10.11/ 1.30	15.11.11	SRTM, Nanded
17	Archery (M&W)	20.10.11 M 21.10.11 W	MDU, Rtk	20 & 21.10.11	10.11.11	Bil. Patiala
18	Chess (M)	20 to 22.10.11	Vaish coll. Rtk	22.10.11/ 11 am	27.11.11	VIT Vellore
19	Football (W)	22 to 24.10.11	GC(W) Rohtak	24.10.11/ 1.30 pm	5.11.11	Annamalai
20	Lawn Tennis (M)	25 to 26.10.11	MDU, Rtk	26.10.11/ 1.30 pm	30.11.11 IZ	Manipal Uni.



21.	Baseball (W)	29 to 31.10.11	H.G.C.Sonipat	31.10.11/ 11.30	26.11.11	Cuttack
22.	Cricket (M)	20.10.11 to 2.11.11	V.C.Rtk,Z-A G.C.BWN, Z-B KLP RWR, Z-C DGC, GGN, Z-D	3.11.11/ 9.00 am	10.12.11IZ	VTU, Dehradun BHU Varansi
23.	Baseball (M)	2 to 4.11.11	MDU, Rtk.	4.11.11/ 11.30	26.11.11	Cuttack
24.	Korfball	4 & 5.11.11	MDU, Rtk	5.11.11/ 1.30 pm		VACANT
25.	Handball (M & W)	5 to 7.11.11 M 8 to 10.11.11 W	MDU, Rtk	7.11.11/ 2 pm M 10.11.11/ 2 pm W	10.12.11 IZ	PU, Chd
26.	Hockey (W)	5 to 8.11.11	MDU, Rtk	8.11.11/ 12 noon	20.12.11IZ	VACANT
27.	Athletics (M&W)	7 to 9.11.11	-db-	During Compt.	17.12.11	Banglore
28.	Wrestling (M&W)	10 to 11.11.11 12 to 13.11.11	Govt.College, Faridabad	11.11.11/12.30 M 13.11.11/12.30 W	10.12.11	CDLU Sirsa
29.	Hockey (M)	15 to 18.11.11	Jat Coll.Rtk	18.11.11/ 2 pm	20.12.11 IZ	VACANT
30.	Softball (M)	1 to 4.12.11	Jat Coll. Rtk	4.12.11/ 9.00 am	25.12.11	PU, Chd
31.	Softball (W)	4 to 6.12.11	GC (W) Rohtak	6.12.11/ 9.00 am	25.12.11	-db-
32.	Gymnastics (M&W)	5.12.11 M 6.12.11 W	DAV Cent. Faridabad	During Compt.	25.12.11	GNDU, Amritsar
33.	Table Tennis (M&W)	6 to 7.12.11 M 8 to 9.12.11 W	Vaish Coll. Engg. Rtk.	7.12.11/ 2pm M 9.12.11/ 2pm W	9.1.12 IZ	RTM, Nagpur
34.	Power Lifting (M)	15 to 16.12.11	MDU Rtk	During compt.	19.1.12	VACANT
35.	Weight Lifting (M)	18 to 19.12.11	-db-	-db-	-db-	-db-
36.	Best Physique (M)	20.12.11	-db-	-db-	-db-	-db-
37.	Power Lifting (W)	21.12.11	-db-	-db-	-db-	-db-
38.	Weight lifting (W)	22.12.11	-db-	-db-	-db-	-db-
39.	Basketball (M)	15 to 17.12.11 & 19 to 20.12.11	Aggarwal Ballabgarh Z-B & DCS Edu. Gohana Z-A & Inter Zonal	21.12.11/ 2 pm	26.1.2012 IZ	Raj/Uni Jaipur
40.	Squash Racket (M)	20-21.12.11	MDU, Rtk	21.12.11/ 12noon	2nd week of Jan.12	Pune
41.	Taekwando (M&W)	15 & 16.12.11M 17 & 18.12.11W	MDU, Rtk	16.12.11/ 11.30 M 18.12.11/ 11.30 W	25.2.12	Imphal
42.	Volleyball (M)	5 to 9.1.12	G.C.Bhiwani	9.1.2012/ 2.00 pm	NZ IZ 10.2.2012	MJP Ranchikhand Bareilly
43.	Kabaddi (M) HS	5 to 7.2.12	Jat Coll.Rtk	-----	-----	-----
44.	Kabaddi (W) HS	8 to 10.2.12	VMM, Rtk	-----	-----	-----
45.	Yoga (M&W)	15 & 16.2.12	MDUSC Rtk	-----	-----	-----
46.	Relay Races (M)	19.2.12	-db-	-----	-----	-----

## **The Selection Trials of the University teams for the session 2011-12 will be held as per schedule**

- |     |  |  |
|-----|--|--|
| 1.  | Cross Country ( M & W)                         | MDU Sports Complex,Rohtak on 28.8.2011 starting from 5.30 A.M.                         |
| 2.  | Kho Kho(Women)                                 | VMM, Rohtak on 5.9.2011 at 11.00 am  |
| 3.  | Kabaddi (W)                                    | JVMGRR Coll.Ch.Dadri 8.9.2011 at 11.30 AM  |
| 4.  | Swimming & Water Polo(M)                       | 7 to 9.9.2011 during competition at MDU Sports Complex ( Swimming pool), Rohtak        |
| 5.  | Netball(men)                                   | NRS Govt.coll.Rohtak on 12.9.2011 at 11.30 AM  |
| 6.  | Football(M)                                    | Ahir college Rewari 13.9.2011 at 10.00 am  |
| 7.  | Netball (Women)                                | KMV, Kharkhauda on 15.9.2011 at 11.30 noon   |
| 8.  | Basketball (W)                                 | MKJKM, Rohtak 23.9.2011 at 12.00 noon  |
| 9.  | Pistol Shooting & Rifle Shooting (Men & Women) | MDU sports complex, Rohtak 5.10.2011 starting from 10.00 am collectively.              |
| 10. | Cricket(women)                                 | MDU Sports Complex, Rohtak 7.10.2011 starting from 9.30 am sharp.                      |
| 11. | Badminton(Men & women)                         | MDU Sports Complex, Rohtak 7.10.11 at 1.30 PM respectively.                            |
| 12. | Boxing (M&W)                                   | MDU sports complex, Rohtak 7 & 8.10.11 at 10. am respectively.                         |
| 13. | Volleyball(Women)                              | D.Govt. Coll. Gurgaon 9.10.11 at 12.30 PM  |
| 14. | Kabaddi(Men)                                   | MDU sports complex, Rtk 9.10.11 at 1.30 PM   |
| 15. | Judo (men & women)                             | MDU Sports Complex, Rohtak 15.10.11 (men) & 16.10.11 (women) at 11.30 am respectively. |
| 16. | Kho Kho(Men)                                   | LN Hindu College, Rohtak 17.10.11 at 1.30 AM   |
| 17. | Archery( Men & women)                          | MDU Sports Complex, Rohtak 20 & 21.10.2011 starting from 9.30 am.                      |

18.	Chess (men)	Vaish College, Rohtak on 22.10.11 at 11.00 am
19.	Football (Women)	Govt.(W) College, Rohtak 24.10.11 at 2.00 PM.
20.	Lawn Tennis (Men)	MDU Sports Complex, Rohtak 26.10.11 at 1.30 PM.
21.	Baseball (Women)	Hindu Girls Coll. Sonipat 31.10.11 at 11.30 AM
22.	Cricket (Men)	MDU Sports Complex, Rohtak 3.11.11 starting from 9.00 am sharp.
23.	Baseball (Men)	Govt. College, Bahadurgarh on 4.11.11. at 11.30 am.
24.	Korfball	MDU Sports Complex, Rtk 5.11.11 at 1.30 pm
25.	Handball (Men & Women)	MDU Sports Complex, Rohtak on 7.11.11 at 12.30 pm (Men Section) and on 10.11.11 at 12.30 pm (Women Section).
26.	Hockey (Women)	MDU Sports Complex, Rohtak 8.11.11 at 12.00 noon.
27.	Athletics (Men & Women)	MDU Sports Complex, Rohtak from 7 to 9.11.11 during the athletic meet.
28.	Wrestling (Men & Women)	Govt.Coll.Faridabad 11.11.11 & 13.11.11 starting from 12.30 pm respectively.
29.	Hockey (Men)	Jat College, Rohtak on 18.11.11 at 11.30 am.
30.	Softball (Men)	Jat College, Rohtak 3.12.11 at 9.00 am
31.	Softball (Women)	Govt. (Women) College, Rohtak 6.12.11 at 9.00 am.
32.	Gymnastics (Men & Women)	DAV Cent. College, Faridabad on 5 & 6.12.2011 during the competitions.
33.	Table Tennis (M & W)	Vaish Engg.Coll. Rtk on 7 & 9.12.11 at 2.00 PM
34.	Power Lifting (Men)	MDU Sports Complex, Rohtak 15 & 16.12.11 during competition
35.	Weight lifting (Men)	MDU Sports Complex, Rohtak 18 & 19.12.11 during competition
36.	Best Physique (Men)	MDU Sports Complex, Rohtak 20.12.11 during competition

- |     |                        |  |
|-----|------------------------|--|
| 37. | Power Lifting (Women)  | VMM, Rohtak 21.12.11 during competition  |
| 38. | Weight lifting (Women) | VMM, Rohtak 22.12.11 during competition  |
| 39. | Basketball (Men)       | D.C.S.College of Edu. Gohana on 21.12.11 at 2.00 pm.                                     |
| 40. | Squash Racket (Men)    | MDU Sports Complex, Rohtak 21.12.11 at 11.30 am  |
| 41. | Taekwondo (M&W)        | MDU Sports Complex, Rohtak on 16.12.11.(Men) & 18.12.11 at 11.30 am (Women)respectively. |
| 42. | Volleyball (Men)       | Govt. Coll., Bhiwani on 9.1.2012 at 2.00 PM.   |

The Interested/ outstanding sports persons may appear for the selection trials on the above said dates, timings and venues along with eligibility performa duly filled in and signed by the Principal of the concerned College/Department/Institution, I-cards of the current session & Trials fee @ Rs.30/- per head per game.

**Formation of Club Committee of Various Games  
For Session 2011-12**

**CHESS**

1.	Dr. Rashmi Lochab	Chairperson	Principal MKIK Rohtak
2.	Smt. Sheela Gahlawat	Member	U.T.D. MDU
3.	Dr. Kavita Dhull	Member	Deptt. of Law MDU
4.	Dr. Sunil Garg	Member	V.C. Rohtak
5.	Sh. Chirag Rajan	Member	V.C. of Engg. Rohtak
6.	Secretary		MDUSC

**TEBLE-TENNIS (W)**

1.	Dr. K. K. Garg	Chairman	Principal V.C. Engg. Rohtak
2.	Smt. Maya Devi	Member	A.M.M. Bhiwani
3.	Mr. Parveen Chopra	Member	G.C.W. Rohtak
4.	Dr. Sapna Garg	Member	Deptt. of Chemistry MDU
5.	Dr. Renu	Member	VBRCMC Bhel
6.	Secretary		MDUSC

**TABLE-TENNIS (M)**

1.	Sh. S.Z.H. Naqul	Chairman	G.C. Jhajjar
2.	Sh. Chander Shekhar	Member	G.C. Bahadurgarh
3.	Dr. Rajender Sharma	Member	G.B. Edu. College, Rohtak
4.	Sh. Sanjay Jindal	Member	V.C. of Engg. Rohtak
5.	Secretary		MDUSC

**KHO-KHO (M)**

1.	Dr.	Chairman	Principal L.N.Hindu College Rohtak
2.	Dr. S.P. Shokeen	Member	T.R. College of Edu. Sonapat
3.	Smt. Munnii Joon	Member	V.M.M. Rohtak
4.	Sh. Bhupender Singh	Member	J.V.M. Charkhi Dadri
5.	Secretary		MDUSC

### **KHO-KHO (W)**

1.	Smt. Kalawati Godara	Chairperson	K.L.P. Rewari
2.	Smt. Sarita Chaudhary	Member	Deptt. of Phy. Edu. MDU
3.	Smt. Chander Kalan	Member	R.D.P. School Rewari
4.	Smt. Munni Joon	Member	V.M.M. Rohtak
5.	Sh. Sunil Dabbas	Member	G.C. Sect. 14, Gurgaon
6.	Secretary		MDUSC

### **SWIMMING & WATER-POOL**

1.	Dr. S.R. Ahalawat	Chairman	Deptt. of Sociology MDU
2.	Sh. B.S. Dhull	Secretary	Swimming Coach MDU
3.	Sh. Tejpal Singh	Member	A.D.P.E. MDU
4.	Sh. Jaipal	Member	G.C. Dubaldhan
5.	Sh. Anil Sharma	Member	MVNIET Palwal
6.	Secretary		MDUSC

### **BADMINTON (M)**

1.	Dr. S.S. Goyal	Chairman	Principal Hindu College, Sonapat
2.	Dr. Kapil Sharma	Member	K.M.C. of Edu. Bhiwani
3.	Dr. Mitesh Kumar	Member	G.C. Bhiwani
4.	Sh. Naresh Rathee	Member	C.R.A. Sonapat
5.	Sh. B.K. Garg	Member	Hindu College, Sonapat
6.	Secretary		MDUSC

### **BADMINTON (W)**

1.	Dr. Jogender Ahlawat	Chairman	Principal G.C. Birhor
2.	Dr. Kapil Sharma	Member	K.M.C. of Edu. Bhiwani
3.	Dr. Supriti	Member	D.S.W. MDU
4.	Sh. M.K. Jain	Member	J.V.M.G.R. Charkhi Dadri
5.	Dr. Kewal Krishan	Member	Deptt. of Phy. Edu. MDU
6.	Secretary		MDUSC

### **NET-BALL (M & W)**

1.	Dr. Satyender Khatkar	Chairman	Director, Dept. of Engg.& Tech. MDU
2.	Smt. Darshna	Member	Kanya College, Kharkhoda
3.	Dr. Radhika Kamal	Member	M.K.J.K.M. Rohtak
4.	Mrs. Suman Tanwar	Member	V.C., Bhiwani
5.	Secretary		MDUSC

### **POWER-LIFTING (M)**

1.	Sh. Ombir Singh	Chairman	N.R.S.G..C. Rohtak
2.	Sh. S.K. Atri	Member	V.C. Bhiwani
3.	Dr. D.C. Sapha	Member	G.C. Gohana
4.	Sh. Naresh Hooda	Member	Gym Coach, MDU
5.	Secretary		MDUSC

### **WEIGHT-LIFTING (M)**

1.	Dr. O.P. Ahalawat	Chairman	Principal N.R.S.G.C. Rohtak
2.	Dr. Sunil Garag	Member	V.C. Rohtak
3.	Dr. D. C. Sapha	Member	G.C. Gohana
4.	Sh. Sanjay Jindal	Member	V.C. Engg. College, Rohtak
5.	Sh. Naresh Hooda	Member	Gym. Coach MDU
6.	Secretary		MDUSC

### **BEST-PHYSIQUE (M)**

1.	Dr. Ajay Rajan	Chairman	IMSAR, MDU
2.	Sh. S.K. Atri	Member	V.C. Bhiwani
3.	Dr. D.C. Sapha	Member	G..C. Gohana
4.	Sh. Naresh Hooda	Member	Gym Coach MDU
5.	Sh. Sanjay Jindal	Member	V.C. of Engg. College Rohtak
6.	Secretary		MDUSC

### **POWER-LIFTING & WEIGHT LIFTING (W)**

1.	Dr. Sudha Sharma	Chairperson	Principal RDSPGC Rewari
2.	Sh. Naresh Hooda	Member	Gym. Coach, MDU

3.	Sh. Subhash Sharma	Member	Judo Coach MDU
4.	Dr. Radhika Kamal	Member	M.K.J.K.M. Rohtak
5.	Smt. Surjeet Neema	Member	V.M.M. Rohtak
6.	Secretary		MDUSC

### **FOOTBALL (M)**

1.	Dr. Shamsheer Ahalawat	Chairman	Principal G.C. Gohana
2.	Sh. Dharmender Kadian	Member	G..C. Dujana
3.	Sh. Amit Chhikara	Member	G..C. Bahadurgarh
4.	Sh. Narender Hooda	Member	P.D.M. Engg. College Badli
5.	Dr. Harinder Sangwan	Member	GGDSD College Palwal
6.	Secretary		MDUSC

### **FOOTBALL (W)**

1.	Dr. S.C. Sahani	Chairman	Principal GCW Rohtak
2.	Dr. Ramesh Sindhu	Member	Athl. Coach MDU
3.	Smt. Asha Dahiya	Member	S.M.M.Palwal
4.	Smt. Sunita Chaudhary	Member	V.M.M. Bahadurgarh
5.	Secretary		MDUSC

### **BASKETBALL (M)**

1.	Dr. B.S. Rathee	Chairman	HOD Phy. Edu. MDU
2.	Sh. Balbir Singh	Member	G..C. Hodal
3.	Sh. R.K. Hooda	Member	Wrestling Coach MDU
4.	Dr. Anjana Garg	Member	Deptt. of Public Admn. MDU
5.	Secretary		MDUSC

### **BASKET BALL (W)**

1.	Dr. S. Beniwal	Chairperson	A.D.S. (F) MDU
2.	Dr. Kavita Dhull	Member	Deptt. of Law MDU
3.	Smt. Sunita Chaudhary	Member	V.M.M. Bahadurgarh
4.	Smt. Renu Hooda	Member	G.C. (W) Rohtak
5.	Ms. Minakshi	Member	M.K.J.K. Rohtak
6.	Secretary		MDUSC



### **SOFTBALL (M)**

1.	Dr. Raj Kumar	Chairman	IMSAR, MDU
2.	Sh.Kapil Sharma	Member	K.M.College of Edu. Bhiwani
3.	Sh.Bhupender Singh	Member	JVM GGR Charkhi Dadri
4.	Sh. Pardeep Kundu	Member	NRSGC Rohtak
5.	Dr. Vipin Gupta	Member	Vaish College Bhiwani
6.	Secretary		MDUSC

### **SOFTBALL (M)**

1.	Dr. Laxmi	Chairperson	Principal GC(W), L.Majra
2.	Smt.Parveen Chopra	Member	G..C.W. Rohtak
3.	Smt. Meenakshi Kadiyan	Member	MKJK Rohtak
4.	Dr. Sonia Malik	Member	Psy. Deptt. MDU
5.	Dr. Randhir Sangwan	Member	Deptt. of Geog. MDU
6.	Secretary		MDUSC

### **VOLLYBALL (M)**

1.	Dr. K.S. Yadav	Chairman	Principal, G..C. Mohindergarh
2.	Sh. Multan Singh	Member	BLJSM Tosham
3.	Dr. Ranbir Gulia	Member	Deptt. of Pol. Sc. MDU
4.	Sh. Naresh Hooda	Member	Gym Coach MDU
5.	Dr.Randhir Sangwan	Member	Deptt. of Geog. MDU
6.	Sh. Surender Sharma	Member	Lect. in History, V.C. Rohtak
7.	Secretary		MDUSC

### **VOLLYBALL (W)**

1.	Smt. Jayoti Juneja	Chairperson	Principal G.V.M. College Sonapat
2.	Smt.Savita Chaudhary	Member	G.V.M. Sonapat
3.	Dr. Raj Bala	Member	T.R. Girls College Sonapat
4.	Sh. Naresh Hooda	Member	Gym. Coach MDU
5.	Smt. Asha Dahiya	Member	S.S.M.Palwal
6.	Secretary		MDUSC

### **HANDBALL (M)**

1.	Dr. Kewal Krishan	Chairman	Deptt. of Phy. Edu. MDU
2.	Sh. Dheeraj Sangwan	Member	Ahir College Riwari
3.	Sh. Sunil Malik	Member	C.R.A. Sonapat
4.	Sh. B.S. Dhull	Member	Swimming Coach MDU
5.	Sh. Satya Dev Malik	Member	Handball Coach MDU
6.	Secretary		MDUSC

### **HANDBALL (W)**

1.	Dr. Arora	Chairman	Principal GGSD College Palwal
2.	Smt. Maya Yadav	Member	AMM Bhiwani
3.	Dr.Raj Bala	Member	T.R. Girls, Sonipat
4.	Sh. Satdev Malik	Member	Handball Coach MDU
5.	Sh. Kartar Singh	Member	D. Govt. College Gurgaon
6.	Secretary		MDUSC

### **GYMNASTICS (M & W)**

1.	Dr. Rameshwari Devi	Chairperson	Deptt. of Phy. Edu. MDU
2.	Dr. Narender Singh	Member	DAV Cent. College Faridabad
3.	Smt. Rajani Saini	Member	DSW MDU
4.	Smt. Sarita Chaudhary	Member	Deptt. of Phy. Edu. MDU
5.	Dr. Jagwanti Deswal	Member	DSW Office MDU
6.	Secretary		MDUSC

### **BOXING (M)**

1.	Prof. Radhey Shyam	Chairman	Deptt. of Psychology MDU
2.	Sh. Pardeep Malik	Member	NRS GC Rohtak
3.	Sh. Raminder Hooda	Member	Jat College Rohtak
4.	Sh. Randeep Rana	Member	Deptt. of Eng. MDU
5.	Sh. Ombir Singh	Member	NRS G.C. Rohtak
6.	Dr. R.S. Rana	Member	Boxing Coach, MDU
7.	Secretary		MDUSC

### **BOXING (W)**

1.	Dr. Shalini Singh	Chairperson	Deptt. of Psychology MDU
2.	Smt. Maya Devi	Member	AMM Bhiwani
3.	Sh. Sunil Dabaas	Member	G.C. Sec. 14 Gurgaon
4.	Sh. Pardeep Malik	Member	NRS GC Rohtak
5.	Dr. R.S. Rana	Member	Boxing Coach MDU
6.	Secretary		MDUSC

### **WRESTLING (M)**

1.	Dr. Nav Rattan Sharma	Chairman	Deptt. of Psychology MDU
2.	Dr. R.P. Garg	Member	Deptt. of Phy. Edu. MDU
3.	Dr. Suresh Malik	Member	G.C. Bhiwani
4.	Sh. Baljeet Singh Nandal	Member	Jat College Rohtak
5.	Sh. R.K. Hooda	Member	Wrestling Coach MDU
6.	Dr. Pawan Hooda	Member	CRA College Sonapat
7.	Secretary		MDUSC

### **WRESTLING (W)**

1.	Dr. Monika Verma	Chairperson	Principal T.R.Girls College Sonapat
2.	Dr. Radhika Kamal	Member	MKJKM, Rohtak
3.	Smt. Surjeet Neema	Member	VMM Rohtak
4.	Sh. Kultaj Singh	Member	UTD MDU
5.	Sh.R.K. Hooda	Member	Wrestling Coach MDU
6.	Dr. R.P. Garg	Member	Deptt. of Phy. Edu MDU
7.	Secretary		MDUSC

### **CRICKET (M)**

1.	Dr. S.K.Sharma	Chairman	Director PGRC Rewari
2.	Dr. Anil Tanwar	Member	V.C. Bhiwani
3.	Sh. M.S. Sheoran	Member	V.C. Rohtak
4.	Sh. Mnoj Kumar	Member	SJK College Kalanaur
5.	Sh. Satdev Malik	Member	MDU, Rohtak
6.	Sh. Wazir Singh	Member	Govt.College Bhiwani
7.	Secretary		MDUSC

### **CRICKET (W)**

1.	Prof. H.G. Ghos Roy	Chairman	IMSAR MDU
2.	Dr.Vinod Bala	Member	Deptt. of Chem. MDU
3.	Smt.Maya Yadav	Member	AMM Bhiwani
4.	Sh. Mujjammal Hayat	Member	AFSET Faridabad
5.	Sh.Purshotam Bansal	Member	Vaish College Rohtak
6.	Sh. Kuldeep Chhikara	Member	Deptt.of Commerce MDU
7.	Sh. R.K. Gupta	Member	Hindu College Sonapat
8.	Secretary		MDUSC

### **HOCKEY (M)**

1.	Dr. Somveer Rathee	Chairman	IMSAR, MDU
2.	Sh. Baljeet Singh Nandal	Member	Jat College Rohtak
3.	Sh.Sunil Malik	Member	CRA Sonapat
4.	Sh. K.S. Saini	Member	Hockey Coach MDU
5.	Sh. Phool Kumar	Member	G..C.W. Lakhan Majra
6.	Secretary		MDUSC

### **HOCKEY (W)**

1.	Dr. Monika Verma	Chairperson	Principal T.R.G.C. Sonapat
2.	Smt.Surjeet Neema	Member	V.C. Rohtak
3.	Sh. S.P. Yadav	Member	S.P. College of Edu. Rewari
4.	Sh.K.S. Saini	Member	Hockey Coach MDU
5.	Smt. Anu Rathee	Member	C.R.A. Sonipat
6.	Secretary		MDUSC

### **JUDO (M)**

1.	Dr. O.D. Sharma	Chairman	Principal BLJS College Tosham
2.	Dr. Suresh Malik	Member	G..C. Bhiwani
3.	Sh. Narender	Member	D.A.V. Faridabad
4.	Sh. Subhash Sharma	Member	Judo Coach MDU
5.	Dr. Sewa Singh	Member	Deptt. of Pub. Adm. MDU
6.	Secretary		MDUSC

### **JUDO (W)**

1.	Prof. Asha Kadian	Chairperson	Deptt. of Eng. MDU
2.	Dr. Mukesh Goyat	Member	MKJK Rohtak
3.	Smt. Hemlata	Member	D.A.V. Kosali
4.	Sh. Subhash Sharma	Member	Judo Coach MDU
5.	Dr. Divya Malhan	Member	IMSAR, MDU
6.	Secretary		MDUSC

### **PISTOL SHOOTING & RIFLE SHOOTING (M &W)**

1.	Dr. Satish Ahuja	Chairman	Principal DAV Cen. College Faridabad
2.	Sh. Dinesh Saharan	Member	NRS GC Rohtak
3.	Sh. Mange Ram	Member	G.C. Dujana
4.	Sh. Balbeer Singh	Member	G.C. Hodal
5.	Sh. Nand Kishore	Member	Aggarwal College Balabhgarh
6.	Dr. R.S. Rana	Member	Boxing Coach MDU
7.	Sh. Krisham Kumar	Member	GBD College Rohtak
8.	Secretary		MDUSC

### **ATHLETICS (M)**

1.	Dr. Amar Singh	Chairman	Deptt. of History MDU
2.	Sh. I.S. Balyaan	Member	Hindu College Sonapat
3.	Sh. Bhupender Kadiyan	Member	J.V.M. Charkhi Dadri
4.	Dr. Ramesh Sindhu	Member	Athletic Coach MDU
5.	Sh. Dharamvir Ahlawat	Member	D.S. Office Rohtak
6.	Secretary		MDUSC

### **ATHLETICS (W)**

1.	Dr. Kewal Krishan	Chairman	Deptt. of Phy. Edu. MDU
2.	Dr. Ramesh Sindhu	Member	Athletic Coach MDU
3.	Sh. Balbeer Singh	Member	G..C. Hodal
4.	Sh. I.S. Balyaan	Member	Hindu College Sonipat
5.	Smt. Maya Yadav	Member	AMM Bhiwani
6.	Sh. Amarjeet Singh	Member	Athletic Coach DS Office
7.	Smt. Parveen Chopra	Member	GCW Rohtak
8.	Secretary		MDUSC

### **KABADDI (M)**

1.	Dr. Balbir Acharya	Chairman	Deptt. of Sanskrit MDU
2.	Sh. Balbir Singh	Member	G.C. Tigaon
3.	Sh.Kultaj Singh	Member	Deptt. of Phy. Edu. MDU
4.	Smt. Munni Joon	Member	VMM Rohtak
5.	Secretary		MDUSC

### **KABADDI (W)**

1.	Dr. S. Singla	Chairperson	Principal VMM Rohtak
2.	Sh. Sunil Dabas	Member	DGC Gurgaon
3.	Smt. Munni Joon	Member	VMM Rohtak
4.	Smt. Darshana Rani	Member	K.M. Kharkhoda
5.	Mrs. Kalawati Godara	Member	KLP College Rewari
6.	Secretary		MDUSC

### **BASEBALL (M)**

1.	Dr. Dharamsukh Dahiya	Chairman	Director C.C.E, MDU
2.	Dr. Raj Bala	Member	TRG College Sonipat
3.	Sh. Naresh Rathee	Member	CRA Sonipat
4.	Dr. Radhika Kamal	Member	MKJK Rohtak
5.	Sh. Virender Singh	Member	G.C. Meham
6.	Secretary		MDUSC

### **BASEBALL (W)**

1.	Dr. Dharamsukh Dahiya	Chairman	Director C.C.E, MDU
2.	Dr. Raj Bala	Member	TRG College Sonipat
3.	Dr. Radhika Kamal	Member	MKJK Rohtak
4.	Smt. Roshani Devi	Member	APJ Charkhi Dadri
5.	Sh. Surender Malik	Member	G.C. Dujana
6.	Secretary		MDUSC

### **SQUASH-RACKET (M & W)**

1.	Dr. Naseeb Singh Gill	Chairman	Deptt. of Computer Sc. MDU
2.	Dr. R.P. Garg	Member	Deptt. of Phy. Edu. MDU
3.	Dr. Kapil Sharma	Member	KMC Edu. Bhiwani
4.	Dr. Parmod Sharma	Member	Deptt. of Geog. MDU
5.	Sh. Dheeraj Trikha	Member	V.C. Bhiwani
6.	Secretary		MDUSC

### **LAWN-TENNIS (M & W)**

1.	Dr. Ramesh Kumar	Chairman	ADPE, MDU
2.	Dr. D.S. Rathee	Member	Jat College Rohtak
3.	Dr. Sudheer Bansal	Member	Deptt. of Geog. MDU
4.	Sh. Naresh Yadav	Member	G.C. Birohar
5.	Sh. Vikas Siwach	Member	U.I.E.T. MDU
6.	Secretary		MDUSC

### **KORF-BALL (M & W)**

1.	Dr. B.S. Rathee	Chairman	HOD Phy. Edu. MDU
2.	Dr. Manvender Gahlawat	Member	Deptt. of Bio-Tech. MDU
3.	Dr. R.P. Garg	Member	Deptt. of Phy. Edu. MDU
4.	Sh. Surender Sangwan	Member	NRS GC Rohtak
5.	Sh. Satyender	Member	Coach D.S.O. Rohtak (Special Invitee Game Expert)
6.	Secretary		MDUSC

### **ARCHERY (M & W)**

1.	Dr. Indira Dhull	Chairperson	Deptt. of Edu. MDU
2.	Sh. Jagbir Dagar	Member	G.C. Ballabgarh
3.	Smt. Shobha Narang	Member	G.C. Sec-14, Gurgaon
4.	Sh. Net Ram	Member	G.C. Sec-14, Gurgaon
5.	Dr. Vikas Kundu	Member	Geeta College of Edu. Butana Sonipat
6.	Sh. Chirag Singh	Member	V.C. of Engg. Rohtak
7.	Secretary		MDUSC

### **CROSS COUNTRY (M & W)**

1.	Dr. Narender Garg	Chairman	HOD Commerce MDU
2.	Sh. Dharmender	Member	NRS GC Rohtak
3.	Dr. Ramesh Sindhu	Member	Athletic Coach MDU
4.	Smt. Raj Bala	Member	D.S. Office Rohtak
5.	Sh. Dharambir Ahalawat	Member	D.S. Office Rohtak
6.	Sh.Mange Ram	Member	G.C. Dujana
7.	Sh. Bhupender Kadian	Member	JVMGRR Ch. Dadri
8.	Dr. Krishana Acharya	Member	Deptt. of Sanskrit MDU
9.	Secretary		MDUSC

### **TAEKWANDO**

1.	Dr.R.R. Saini	Chairman	Deptt. of Commerce MDU
2.	Dr. Jitender Kumar	Member	Deptt. of Education MDU
3.	Dr. R.P. Garg	Member	Deptt. of Phy. Edu MDU
4.	Dr. Jaipal Sharma	Member	G.B.D. Rohtak
5.	Dr. Suman Tanwar	Member	V.C. Bhiwani
6.	Secretary		MDUSC

### **VAOMNAM**

1.	Sh. Nafe Ram	Chairman	Daronacharya College Gurgaon
2.	Sh. Manoj Kumar	Member	SJK Kalanaur
3.	Smt. Surjeet Neema	Member	VMM Rohtak
4.	Sh. Mukesh Goyal	Member	V.C. Bhiwani
5.	Dr. Savita	Member	G.C.(W) Bhiwani
6.	Dr. Sapna Garg	Member	Deptt. of Chemistry MDU
7.	Dr. Omender Singh	Member	Deptt. of Education MDU
8.	Secretary		MDUSC



**Rates for Officiating Charges for  
Inter-College and Inter-University Tournaments.**

<b>Sr. No.</b>	<b>Name of the Games</b>		<b>Rates</b>
1.	Table Tennis, Badminton, Water Polo Squash Racket, Softball, Tennis, Baseball Kho-Kho, Netball, Kabaddi Hockey, Football, Basketball, Volleyball Handball, Korfball	Umpire, Refree Judges Table Official, Lineman, Time keeper, Scorer	Rs. 200/- per match  Rs. 140/- per match
2.	Cricket, Wrestling, Boxing, Gymnastics, Weight Lifting, Power Lifting, best physique, Athletics, Swimming, Diving, Yoga, Judo, Relay Races, Archery, Shooting, Chess (one official in 4 tables) Cross Coutry, Taekwando, Vaommam	Refree, Judges, Timekeeper Scorer, Umpire	Rs. 350/- per day
3.	Track marking fee (Technical Official) Observer Fee Club/Selection Committee Sub Committee appointed by E.V., MDUSC		Rs. 350/- per day Rs. 350/- per day Rs. 350/- per day Rs. 250/- per day
4.	Ministerial Staff Groundman & Class- IV Coaching fee/training allowance fee DA to Coach and Manager not in service Local conveyance charges for students/ players		Rs. 200/- per day Rs. 120/- per day Rs. 200/- per day Rs.100/- per day As per uni./Govt. rules

**Tentative Number of Officials Approved  
for Conduct of University Fixtures in Different  
Games in Each Section**

<b>Sr. No.</b>	<b>Name of Game</b>	<b>No. of Officials per day</b>
1.	Athletics	50 Technical officials + office staff
2.	Gymnastics	6 Judges + Office staff
3.	Boxing	15 Judges + office staff
4.	Wrestling	15 Judges + office staff
5.	Swimming	25 Judges + office staff
6.	Diving	7 Judges + office staff
7.	Weight Lifting	8 Judges + office staff
8.	Power Lifting	8 Judges + office staff
9.	Best Physique	6 Judges + office staff
10.	Yoga	6 Judges + office staff
11.	Cross country	35 Judges + office staff
12.	Relay races	20 Judges + office staff
13.	Judo	10 Judges + office staff
14.	Archery	5 Judges & 6 scorers + office staff
15.	Chess	Each official will supervise at least 4 table total officials = 5 per round
		<b>Per Match</b>
16.	Hockey	2 Referee, 2 Table officials
17.	Football	1 Referee, 2 Umpire, Table official - 1
18.	Cricket	2 - Umpire, 1 Scorer

<b>Sr. No.</b>	<b>Name of Game</b>	<b>No. of Officials per day</b>
19.	Tennis	Referee-1, Linemen- 3
20.	Basketball	Referee - 2, Table officials - 2
21.	Kabaddi	Referee - 1, Umpire- 2, Linemen - 2, Table officials - 2
22.	Waterpolo	Referee - 2, Table officials - 3
23.	Tabel Tennis	Referee - 1, Scorer - 1
24.	Badminton	Referee - 1, Linemen-3, Scorer - 1
25.	Kho-Kho	Referee -1, Umpire -2, Table officials-2
26.	Handball	Referee -2, Table officials - 2
27.	Kabaddi (HS)	Referee - 1, Umpire -2, Table officials -1
28.	Volleyball	Referee -2, Linemen - 2, Scorer- 1
29.	Korfball	Referee -2, Table officials - 2
30.	Softball	Judges- 6

**Note :-**

- (a) The number of office staff will be appointed by the Secretary, MDUSC as per requirement of each game.
- (b) This list does not apply for Inter-University fixtures. The appointment of technical officials for Inter-varsity tournaments will be as per Federation Rules of the concerned game.

## Event According to the Weight Categories

In individual events the following games will be organized according to the weight categories as mentioned below: -

1. **Judo (Men)** 56 Kg, 60Kg, 66Kg, 73Kg, 81Kg, 90Kg, 100Kg, open weight
2. **Judo (women)** 44Kg, 48Kg, 52Kg, 57Kg, 63Kg, 70Kg, 78Kg, open weight
3. **Weight Lifting (Men)** 56Kg, 62Kg, 69Kg, 77Kg, 77Kg, 85Kg, 94Kg, 105Kg, +105 KG
4. **Power Lifting (Men)** 56Kg, 60Kg, 67.5Kg, 75Kg, 82.5Kg, 90Kg, 100Kg, 110Kg, 125Kg, +125Kg
5. **Best Physique(M)** 60Kg, 65Kg, 70Kg, 75Kg, 80Kg, 85Kg, 90Kg, +90Kg
6. **Wrestling(M)** 50Kg, 55Kg, 60Kg, 66Kg, 74Kg, 84Kg, 96Kg, +96Kg
7. **Wrestling (W)** 48Kg, 51Kg, 55Kg, 59Kg, 63Kg, 67Kg-72Kg
8. **Boxing(Men)** Up to 48Kg, 48-51Kg, 51-54Kg, 54-57Kg, 57-60Kg, 60-64Kg, 64-69Kg, 69-75Kg, 75-81Kg, 81-91Kg, +91Kg
9. **Boxing (Women)** Up to 46Kg, 46-48Kg, 48-50Kg, 50-52Kg, 52-54Kg, 54-57Kg, 57-60Kg, 60-63Kg, 63-66Kg, 66-70Kg, 70-75Kg, 75-80Kg, 80-86Kg

### List of LPE's DPE's And Other

Sr. No.	Name	College	Mob. No.	Phone No.
1.	Dr. D.S. Dhul	Director Sports	9355235911 9034840072	01262-219305
2.	Dr. S. Baniwal	Asstt. Director Sports	9813653034	
3.	Dr. R.P. Garg	MDU Rohtak	9896091442	
4.	Dr. Bhagat Singh	MDU	9896222075	
5.	Parveen Chopra	G.C.W., Rtk	9416525909	251116
6.	Dr. Mitesh	G.C., Bhiwani	9416526003	01664-242418
7.	Dr. Suresh Malik	G.C., Gohana	9416378762	01263-252032
8.	Dr. Virendra Singh	G.C., Meham	9416121272	
9.	Om Bir Singh	G.C. Dubaldhan	9416050353	
10.	Bhupender Singh	JUMGRR Coll., Dadri	09255942342	
11.	Pardeep Kundu	Pt. NRS Govt. Coll. Rtk.	9991947710	
12.	Sanjay Jindal	V.C. Engg., Rohtak	9416657744	
13.	Virender Kumar	Sh. L.N. Hindu College, Rohtak	9416576908	01262-315484
14.	Muzzammil Hayat	AL-Falah, FRD	9953512205	0129-4254600-05
15.	Surjeet Neema	V.M.M., Rohtak	9416171760	01262-253845
16.	Munni Joon	V.M.M., Rohtak	9416360760	01262-253848
17.	Mrs. Darshana	K.M.V. Khakhoda	9466256824	0130-2120532
18.	Dr. Jagwanti Dalwal	D.S.W.	9813424408	
19.	Dr. Radhika	M.K.J.K., Rohtak	9466072466	
20.	Mrs. Chander Kalla	R.D.S. Public Girls College, Rewari	9416333339	01274-257399 01274-252290
21.	Kalavati Godara	K.L.P. College, Rewari	9466884699	01274-254964
22.	Dr. Savita	G.V.M., Sonipat	9416812589	2234963
23.	Sarika Kapoor	H.G.C., Sonipat	8929287105	0130-2247248
24.	Dr. Amit Chhikara	G.C., Bahadurgarh	9212335600	01276-230574
25.	Sh. Krishan Kumar	G.B.D. College, Rtk	9255105287	
26.	Jaipal Dhankhar	G.C., Jhajjar	9466490596	01251-251024
27.	Dr. Jagdish Rahar	G.C. Birohar	9050690062 9416120575 9416517396	

Sr. No.	Name	College	Mob. No.	Phone No.
28.	Dr. Havender Sangwan	S.D. College, Palwal	9899090992	01275-252036 259021
29.	Mrs. Sushma Rohilla	C.C.A.S. Jain Girls College, Ganaur, Sonipat	9215760039 9354961121	
30.	Mrs. Hemlata	DAVG College, Kosli	9416426218	01259-275256
31.	Sh. Satya Dev	Hand ball Coach	9466490200	9416288288
32.	Sh. Naresh Hooda	Gym Coach	9416144315	
33.	Sh. K.S. Saini	Hockey Coach	9896876768	
34.	Birender Dhull	Swimming Coach	9896050460	
35.	Subhash Sharma	Jodo Coach	9416469699	
36.	Raj Kumar Hooda	Wrestling Coach	9812313300	
37.	Dr. Ravinder Rana	Boxing Coach	9896824400	
38.	Dr. Ramesh Sindhu	Athletic Coach	9255744273	
39.	Sh. Baljit Singh Nandal	Jat College, Rtk	9416357446	294179
40.	Dr. Sunil Garg	Vaish Coll., Rohtak	9416287373	248442
41.	Sh. Purushotam	Vaish Coll., Rohtak	9017186659	
42.	Sh. Suresh Kumar	Vaish Coll., Bhiwani	9354256321	01664-242338
43.	Mrs. Maya Yadav	AMM, Bhiwani	09996021478	
44.	Dr. Kapil Sharma	K.M. Coll.of Edu.,Bhiwani	9812301997	01664-242412
45.	Sh. Sunil Malik	CRA Sonipat	9416044533	0130-2242925
46.	Sh. I.S. Balian	Hindu Coll., Sonipat	9466844996	0130-2247259
47.	Dr. Raj Bala	TRGC, Sonipat	9034197844	
48.	Mrs. Suman	TRGC, Sonipat	9416942622	
49.	Dr. SZH Naqvi	G.C. Jhajjar	9671357882	
50.	Mrs. Sunil Dabas	DGC, Gurgaon	09891431771	
51.	Mrs. Shobha Narang	G.C. Sec.-14, Gurgaon	09868141647	
52.	Mrs. Asha Dahiya	SMM Palwal	09466510080	

## **General Instructions**

1. The Organizing Secretary of the tournament must submit the Org.Secy's report with all relating documents / records immediately after the completion of the tournament(s).
2. Without proper kit, no player will be allowed to participate in the tournament.
3. No team will be allowed to take part in the tournament without a responsible team Manager/ Coach of the college concerned.
4. The Org. Secretary will be fully responsible for the proper stay accommodation of the teams & any kind of dispute which may incur during the tournament(s).
5. The presence of a Doctor is must during the tournament to prevent any kind of eventuality which may arise during the competition.
6. For the preparation of certificates of winning teams, the details of the teams i.e. eligibility performa duly signed, proforma 'C' must be handed over to the official of this office at the time of selection trials. This office will not be responsible for any delay in preparing the certificates.
7. Two fresh passport size photographs are required from the players duly signed by the Principals on the back of photographs.
8. The eligibility Performa must be filled in BLOCK LETTERS. The university registration number must also be written if the same have been allotted to the students/ players.
9. All the tournaments shall be conducted according to the rules as adopted by the concerned Fedration of the Game.

**Proforma for the Organising Secretary's Report**

1. Name of the Game : \_\_\_\_\_ Men/Women
2. Tournament (Zonal/Inter-zonal/Both): \_\_\_\_\_
3. Name of the organizing Institution : \_\_\_\_\_
4. Dates of tournament : From \_\_\_\_\_ to \_\_\_\_\_
5. Total No. of Participating teams : \_\_\_\_\_
6. Name of the teams (Institutes) which did not report but were drawn in fixation :
  - (i)
  - (ii)
  - (iii)
  - (iv)
  - (v)
7. Name of teams, which were not accompanied by Manager/Coach and were not, allowed participation.
  - (i)
  - (ii)
  - (iii)
  - (iv)
8. Name of teams winning 1st four positions :

Winner \_\_\_\_\_

Runners-up \_\_\_\_\_

Third position \_\_\_\_\_

Fourth position \_\_\_\_\_



9. Protest(s) lodged, if any, (Give the details with action taken as per HBI Rules) :

---

---

10. General standards of participants : \_\_\_\_\_

11. Name(s) of outstanding players, with college and performance :

Sr. No.	Name of Players	College
(i)		
(ii)		
(iii)		
(iv)		

12. In case of Interzonal tournament, the list of players on the attached proforma with details be submitted along with this report.

13. Any other information.

Org. Secretary  
-----Tournament  
M.D.Univeristy, Rohtak

Countersigned

Principal  
(Seal)

Dated : \_\_\_\_\_

**Note** : This Report must reach the office of the Secretary within 7 days from the end of tournaments.

**Specimen Format for Utilisation Certificate  
to be issued by  
the Principal/ Head of Institution  
UTILISATION CERTIFICATE**

Certified that an amount of Rs. \_\_\_\_\_ has actually been incurred as an expenditure towards organization of \_\_\_\_\_ tournament as per MDUSC rules held from \_\_\_\_\_ to \_\_\_\_\_. The bills of the said expenditure have been kept with the office of the Principal of this college, which can be verified by the Secretary, MDUSC as and when required. The head wise detail of the said expenditure is given below :

<b>Sr. No.</b>	<b>Item/Head of expenses</b>	<b>Amount</b>
1.		
2.		
3.		
4.		
5.		Total

Also verified that a sum of Rs. \_\_\_\_\_ is to be received from the Secretary, MDUSC as per norms as grant-in-aid for organization of this tournament. The net deficit of Rs. \_\_\_\_\_ will be borne by the college/Institution from its own sources.

It is further certified that all the vouchers and the bills has been verified by the Bursar of the College and we are personally satisfied that the expenditure made towards organization of this tournament is in accordance of the MDUSC rules.

Sd/-  
Bursar

Sd/-  
Incharge of the Tournament

Sd/-  
Principal/Head of Institute

**Specimen Format for Sending Entries**

Ph. No. (Off.) \_\_\_\_\_  
(Resi.) \_\_\_\_\_  
No. \_\_\_\_\_  
Dated \_\_\_\_\_

From  
The Principal  
\_\_\_\_\_  
\_\_\_\_\_

To  
The Secretary,  
MDU Sports Council,  
Rohtak.

Sub : Entries for the year \_\_\_\_\_

Dear Sir,  
Kindly enter our following teams for MDU Inter-College Tournament for the year \_\_\_\_\_.

<b>Sr. No.</b>	<b>Name of the Game</b>	<b>Section (M &amp; W)</b>	<b>Entry Fees</b>
1.			
2.			
3.			
4.			

A demand draft No. \_\_\_\_\_ dated \_\_\_\_\_ for the amount of Rs. \_\_\_\_\_ drawn on S.B.I, M.D.U., Rohtak in favour of the Secretary, MDU Sports Council, Rohtak is being enclosed herewith as entry fee. Please, issue a receipt.\

With thanks,

Encl : \_\_\_\_\_

Principal/Head of Instt.  
(with seal)

**ANNEXURE-D**

**Specimen Format of Receipt for Officiating Charge**

Received a sum of Rs. ....(Rupees .....only) from the Principal/DSW/Director, ..... on account of officiating charges for .....Championship for the match played between ..... and ..... on .....at ..... held at ..... as per details given below (share of concerned college).

<b>Sr. No.</b>	<b>Particulars</b>	<b>Amount</b>	<b>Signature</b>
1.	Referee charges	Rs. _____	_____
2.	Umpire charges		
	(i)	Rs. _____	_____
	(ii)	Rs. _____	_____
3.	Linemen (2)	Rs. _____	_____
4.	Scorer (1)	Rs. _____	_____
5.	TA/DA of officials	Rs. _____	_____
6.	Local Conveyance, if any	Rs. _____	_____
	Total	Rs. _____	_____

Countersigned

Dated : \_\_\_\_\_

Organising Secretary

**Note :** Each column must be signed by the person who receives the payment mentioned against it.